



2-8-8-8-2 Triplex Steam Locomotive OPERATOR'S MANUAL

Compatibility

This locomotive is capable of operating on AC or DC output power supplies (See page's 28 & 29 for a complete list of compatible transformers and wiring instructions.) and indoors or outdoors. MTH does not recommend operating the locomotive in inclement weather and strongly suggests that it not be left out in the elements. The locomotive will negotiate an R3 G-Gauge curve track or switch. Additional features may be utilized when controlling the engine with MTH's Digital Command System (DCS).



Passenger Station Announcement

PLEASE READ THIS MANUAL BEFORE USE AND SAVE
WWW.MTHTRAINS.COM

Table of Contents

Set Up Checklist.....	3
Locomotive Coupler Installation.....	3
Setup for R-1 Curve.....	6
Lubrication.....	7
Priming The Smoke Unit.....	7
Checking the Battery.....	8
Placing The Engine On The Track.....	8
Installing the Locomotive Pilot Details.....	9
Basic Operation.....	10
Activating Features Using DC Power.....	10
Using DCS with DC Power.....	11
DCS Polarity Switch.....	12
Activating Features Using AC Power.....	13
Proto-Sound 2.0 Operating Instructions	14
Activating Proto-Sound® 2.0 Conventional Mode Features.....	14
Freight Yard Sounds (FYS) or Passenger Station Announcements (PSA):.....	15
Proto-Coupler™ Operation.....	16
Speed Control.....	17
Locking Locomotive Into A Direction.....	18
Reset To Factory Default.....	18
Automatic Sound Effects.....	18
Maintenance.....	19
Lubricating and Greasing Instructions.....	19
Traction Tire Replacement Instructions.....	20
Light Bulb Replacement Instructions.....	21
Self Charging Battery Back-Up.....	23
ProtoSmoke™ Unit Operation.....	24
Installing the Locomotive Pilot.....	25
Troubleshooting Proto-Sound® 2.0 Problems.....	26
Transformer Compatibility and Wiring Chart.....	29
Recommended AC Transformers.....	30
Additional Features Accessible With The DCS System.....	31
Service & Warranty Information.....	32
Limited One-Year Warranty.....	32

CAUTION: ELECTRIC TOY:

Not recommended for children under 14 years of age without adult supervision. As with all electric products, precautions should be observed during handling and use to prevent electric shock.

WARNING: When using electrical products, basic safety precautions should be observed, including the following:

Read this manual thoroughly before using this device.

- 1 M.T.H. recommends that all users and persons supervising use examine the hobby transformer and other electronic equipment periodically for conditions that may result in the risk of fire, electric shock, or injury to persons, such as damage to the primary cord, plug blades, housing, output jacks or other parts. In the event such conditions exist, the train set should not be used until properly repaired.
- 1 Do not operate your layout unattended. Obstructed accessories or stalled trains may overheat, resulting in damage to your layout.
- 1 This train set is intended for indoor use. Do not use if water is present. Serious injury or fatality may result.
- 1 Do not operate the hobby transformer with damaged cord, plug, switches, buttons or case.

This product may be protected by one or more of the following patents: 6,019,289; 6,280,278; 6,281,606; 6,291,263; 6,457,681; 6,491,263; 6,604,641; 6,619,594; 6,624,537; 6,655,640.

Set Up Checklist

- Install the tender coupler
- Lubricate the locomotive
- Prime the smoke unit
- Check to see whether the batteries need to be charged for full sound effects
- Apply power to run as described in the Basic Operating Section of this manual

Installing The Tender Coupler

This RailKing One-Gauge locomotive tender is designed to accept 3 different types of couplers.

M.T.H. Remote Control ProtoCoupler

Hook and Loop Type Coupler

Kadee No. 829 #1 Scale Coupler

The tender comes equipped with an M.T.H. Remote Control ProtoCoupler that will mate with other G Gauge knuckle couplers and large scale Kadee couplers. The M.T.H. Remote Control ProtoCoupler is designed to mount at two different heights. The M.T.H. Remote Control ProtoCoupler is mounted in the higher position as delivered.



Figure 1a: MTH ProtoCoupler in higher position.



Figure 1b: M.T.H. ProtoCoupler in Lower Position.

The M.T.H. Remote Control ProtoCoupler can be mounted in the lower position by removing the M.T.H. Remote Control ProtoCoupler and inserting the spacer that is provided in the packaging and reattaching the M.T.H. Remote Control ProtoCoupler using the longer screws provided with the spacer. (See Figure 2).

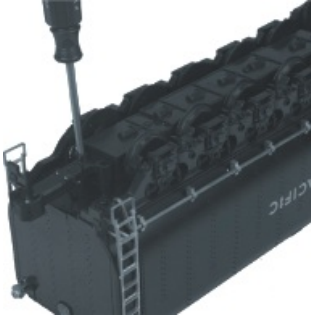

Figure 2a: Unscrew ProtoCoupler

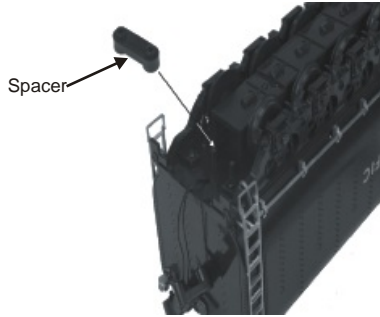

Figure 2b: Add Spacer and reattach ProtoCoupler

When the lower mounting position is used the locking pin must be shortened. The Locking pin has been scored so that it can be easily cut off with a pair of cutters. (See Figure 3).

An M.T.H. hook and loop type coupler is supplied in the packaging and will attach to the coupler mounting in the same manner as the M.T.H. Remote Control ProtoCoupler. Follow this procedure to install the hook and loop coupler:

- Remove the body shell from the tender
- Unplug the M.T.H. Remote Control ProtoCoupler from the wire harness
- Remove the M.T.H. Remote Control ProtoCoupler from the mounting bracket (See Figure 4).
- Attach the hook and loop coupler to the mounting bracket
- Reinstall the body shell.

An adapter plate for mounting a Kadee No. 829 #1 Scale Coupler is supplied in the packaging. The Kadee No. 829 #1 Scale Coupler must be purchased separately from any Kadee coupler retailer.



Figure 3: Shorten locking pin when coupler is in lower position..

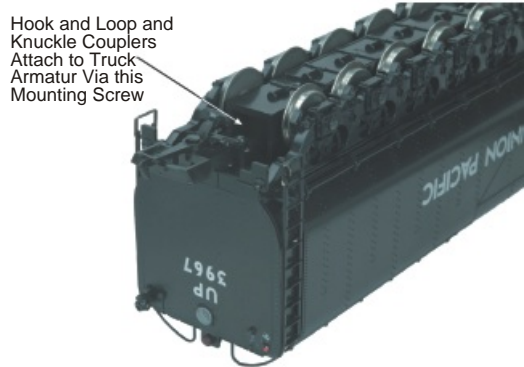

Figure 4: Installing the Hook and Loop type Coupler.

If a Kadee Coupler is to be installed, remove the M.T.H. knuckle or hook & loop coupler and install the Kadee Coupler base included in your locomotive packaging as seen in Figure 5a. Once the coupler base is installed, attach the Kadee Coupler onto the mount (See Fig. 5b) by following the Kadee Coupler's installation guide.

Install Kadee Coupler Mount into mounting holes on tender chassis



Figure 5a

Install Kadee Coupler Onto Coupler Mount Using Kadee supplied screws



Figure 5b

The MTH remote control ProtoCoupler can be opened remotely as described in the following sections or manually by moving the coupler locking pin upward.

In operation with AC track voltage the M.T.H. Remote Control ProtoCoupler can be opened remotely by pressing the whistle button and bell button on the M.T.H. Z-4000 or any AC transformer equipped with a whistle and bell button and listed in the recommended AC transformer chart on page 28. See the actual operation steps to activate the coupler on page 15.

In command operation the M.T.H. Remote Control ProtoCoupler can be opened remotely by pressing the rear uncoupling button on the M.T.H. DCS Remote when using the DCS TIU and Remote Control.

In operation with DC track voltage the M.T.H. Remote Control ProtoCoupler can be opened remotely using a remote uncoupling track section.

Lubrication

You should lubricate the engine to prevent it from squeaking. Use light household oil and follow the lubrication points marked “L” in Fig. 6. Do not over-oil. Use only a drop or two on each pivot point.

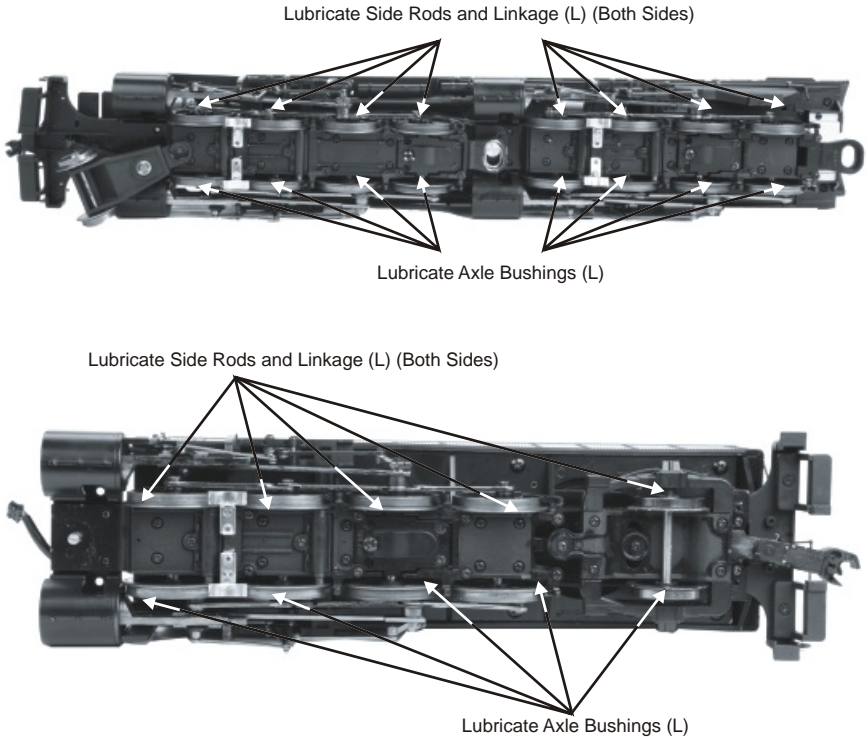

Figure 6. Lubrication Points on the Locomotive and Tender

Priming The Smoke Unit

When preparing to run this engine, add 30-40 drops of smoke fluid through the smokestack. We recommend M.T.H. ProtoSmoke, Seuthe, LGB, or LVTS fluids. Do not overfill the unit or the fluid may leak out and coat the interior engine components.

If you choose not to add the fluid (or have already added the fluid but choose to run smoke-free), rotate the smoke unit knob located inside the boiler front (see Fig. 7) to the off position (rotate clockwise). If you wish to regulate the smoke output intensity, turn the knob between full counterclockwise and full clockwise until the desired smoke output is reached. Failure either to add fluid to the unit or to turn it off may damage the smoke unit heating element and/or wicking material.

While M.T.H. does not recommend operating outdoors in inclement weather (in order to prevent possible damage to the electronics), we have included for your convenience, a smoke stack “cap” inside your locomotive packaging. This cap should be inserted on the smoke stack to prevent moisture from entering the smoke unit chamber.

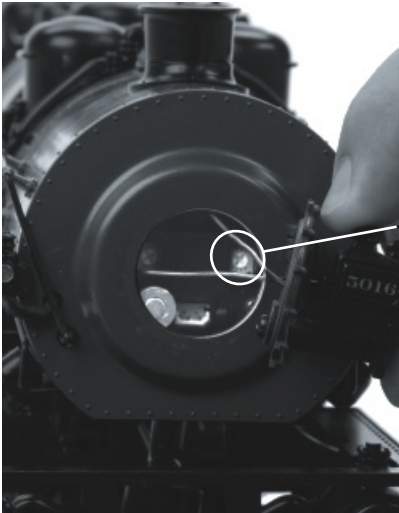

 Running the engine without a primed smoke unit may cause damage

Smoke Unit Control

Figure 7: Smoke Unit Switch
ProtoSmoke Fluid

ProtoSmoke is the recommended fluid for M.T.H. products and can be used in other manufacturers products as well. Choose from 12 different scents:

Christmas, Coal, Diesel, Wood Burning, Coffee, Eggs & Bacon, Vanilla, Candy Cane, Barbeque, Pipe Smoke, Cinnamon Roll, and Apple Pie



2-8-8-2 Triplex Steam Locomotive

Placing The Engine On The Track

Place the engine on the track, then insert the reverse unit plug that extends out of the tender into the receptacle at the back of the boiler cab (Figure 8)

WARNING: DO NOT CONNECT THIS ENGINE TO A TENDER FROM ANOTHER ENGINE; IT MAY CAUSE SERIOUS DAMAGE.

Connect the draw bar between the engine and tender.

At this point, you are ready to begin running your engine.



Figure 8a: Connecting Tender Harness



Figure 8b: Underside View of Connection

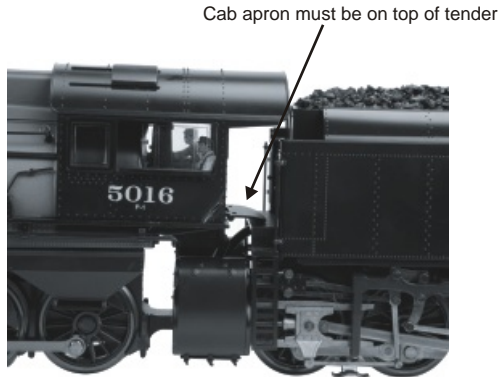

Figure 8c: Correct Connection of Tender Harness

Checking The Battery

You may find, if your locomotive was built several months before you set it up, that the rechargeable batteries have run down and need to be charged before operating. If you notice that the sounds are garbled, test and charge the engine as described in the "Self-Charging Battery Back-Up" on page 23.

Basic Operation

RailKing One-Gauge locomotives can be operated with AC or DC power output transformers. When using DC output power supplies, the user can only control the locomotive speed and direction. The locomotive will still make engine sounds but no bell or whistle control is possible when using a DC output power supply unless the user wishes to hook up the power supply to MTH's separately sold Digital Command System.

As with all G-Gauge locomotives, the Throttle knob or handle controls how fast your train will travel.

Activating Features Using DC Power

Throttle - To increase or decrease track voltage, and therefore train speed, turn or slide the throttle control knob. Turning clockwise will increase voltage and speed, while turning counterclockwise will decrease voltage and speed. Because your RailKing One-Gauge locomotive is equipped with M.T.H.'s Proto-Speed Control feature, the engine will maintain the speed you set after you release the throttle until you turn it again to slow down or speed up the locomotive. This feature works very similarly to the cruise control system found in automobiles and allows the engine to maintain its speed even as it enters curves, traverses grades or coasts down inclines.

Direction - There are two ways to change a locomotive's direction when operating the engine with a DC power supply.

1. Slow the locomotive down using the throttle knob until the engine comes to a complete stop but power still remains on the track. Slide the direction switch on the power supply to the opposite direction and increase the throttle setting again to allow the locomotive to begin running in the opposite direction.
2. While the locomotive is running, slide the direction switch on the power supply to the opposite direction. The locomotive will slow to a gradual stop and then reverse direction and slowly gain speed until it is again travelling at its original speed prior to the direction switch change.

Using DCS With DC Power

M.T.H.'s revolutionary Digital Command System, or DCS, allows users to control their RailKing One-Gauge locomotives in a command control environment. User's can remotely access hundreds of features inside each RailKing One-Gauge locomotive with the wireless remote control. Digital signaling and an easy-to-use interface make using DCS a snap. More information on DCS can be found on page 25 or by visiting www.protosound2.com.

DCS / POLARITY Switch

Your model is equipped with a DCS / POLARITY switch that is used to properly orient the polarity of the power and the DCS signal going to the circuit board.

The DCS / Polarity Switch is located underneath the left side of the firebox. (See Figure 9)

There are 2 situations that may require the operator to change the position the DCS / Polarity Switch.

DC Mode

In DC operation the polarity of the voltage applied to the track rails determines the direction of travel for the engine. If the MTH engine is facing the same direction as other engine(s), but it runs in the opposite direction of the other engine(s) when the power is applied to the track, you will need to select the other position of the DCS Polarity Switch. This will change the direction of travel for the MTH RailKing Gauge-One Engine and will have the MTH engine operating in the same direction as the other engine(s).

DCS Mode

In the DCS mode (using AC or DC). The control electronics is expecting the DCS signal on the high or + side of the transformer / power pack output. If the engine is placed on the track facing the wrong direction, the engine will not receive the DCS Signal and will not be recognized by the Track interface unit (TIU). If the engine is not recognized by the TIU, or if the engine sounds start up when the power is applied to the track with a TIU connected, the DCS / Polarity Switch will need to be moved to the other position.

The DCS / Polarity Switch is oriented so that the switch is moved toward the rail with High / + / Red output terminal from the Transformer / Powerpack / TIU.

If your engine starts out in the direction you want or if the TIU recognizes the engine there is no need to change the setting of the DCS / Polarity Switch.

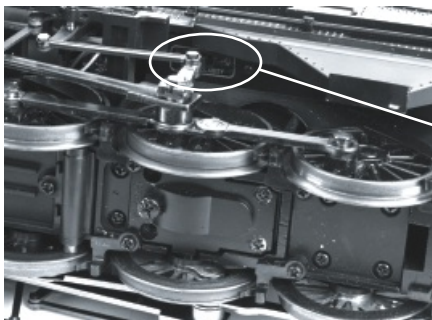

DCS Polarity Switch

Figure 9

Activating Features Using AC Power

Using an AC output transformer equipped with a whistle and bell button will unlock dozens of features inside your RailKing One-Gauge locomotive. Operation is simple by following the simple steps below and on the following pages.

Start Up - Turn the throttle knob up ½-way, until the engine headlight shines bright.

Put the engine into motion by pressing the Direction button on your transformer once. (hold it for approximately 1 second)

If the engine does not begin to move as soon as you firmly press the Direction button, you may not have sent enough voltage to the track to make the train move. Turn the throttle up a bit higher until the train begins to move.

Throttle - To increase or decrease track voltage, and therefore train speed, turn the throttle control knob. Turning clockwise will increase voltage and speed, while turning counterclockwise will decrease voltage and speed. The engine will maintain the speed you set after you release the throttle until you turn it again to change the voltage and speed.

Bell - To sound the bell, in an engine equipped with a bell firmly press and release the Bell button. To turn the bell off, press and release the Bell button again. The bell will continue to ring from the time you turn it on until you press and release the button again to turn it off.

Horn/Whistle - To sound the whistle, firmly press the Horn/Whistle button. The whistle will sound for as long as you continue to depress the button. It will stop when you release the button.

Quillible Whistle (DCS Software 4.0 and Higher Only) The Triplex is equipped with a quillible whistle feature. When using DCS 4.0 or higher software you can dip and quill the whistle just like a real steam whistle. To activate the quillible whistle push the soft key on the DCS Remote labeled SPW. Then roll the speed control thumbwheel forward and backward to vary the sound of the whistle. When the quillible whistle feature is activated the speed control knob will have no effect on the engine speed. The engine will continue at the speed it was going when the quillible whistle feature was activated.

Steaming Whistle (DCS Software 4.0 and Higher Only)

The Triplex is equipped with a steaming whistle. Pressing the soft key FSW activates the steaming whistle. When activated a steam like vapor is expelled from the whistle detail in sync with the sound of the quillible whistle.

The quillible whistle must be activated for the steam feature to function. See page 24 for details on adding smoke fluid to the steaming whistle.

Direction - Your train is programmed to start in neutral. The train will always cycle neutral-forward-neutral-reverse with each press and release of the direction button. The engine is programmed to restart in neutral each time the track voltage is turned off for 25 seconds or more.

Grade Crossing Signal DCS Mode Only - Customers that operate this engine in DCS will find a new feature added to the engine sound set. Now there is a soft key (SXS) that sounds the correct 2 longs, a short and another long whistle blast to announce that the train is approaching a grade crossing.

To sound the grade crossing signal, locate the soft keys at the top of the DCS Remote. Scroll to the left until SXS acronym is showing.

A single push and release of the SXS soft key will produce the correct 2 longs, a short and another long whistle blast of the Grade Crossing Signal.

Anytime you want to sound the Grade crossing Signal just press and release the SXS soft key.

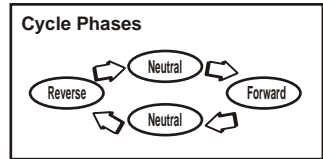

Manual Volume Adjustment

To adjust the volume of all sounds made by this engine, turn the master volume control knob located inside the door on the side rear of the cab clockwise to increase the volume and counter-clockwise to decrease the volume.

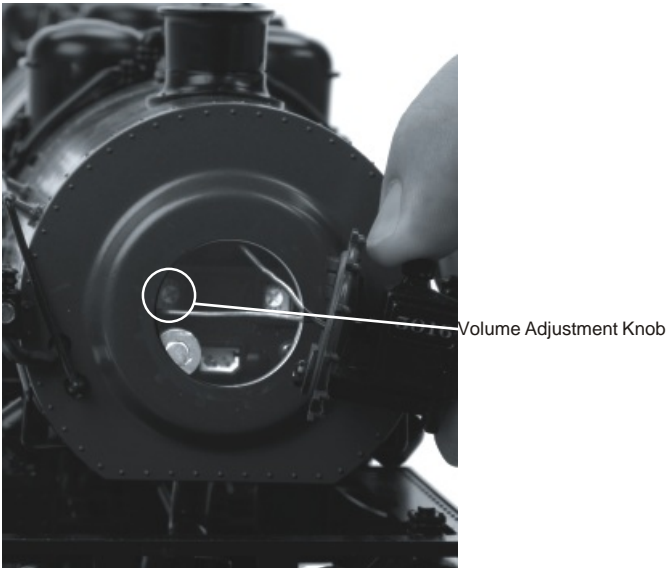

Figure 10

Proto-Sound 2.0 Operating Instructions

The following pages contain the operating instructions for Proto-Sound 2.0 RailKing One-Gauge locomotives when operated with AC output transformers in conventional mode only. Instructions for accessing DCS command mode features accompany the DCS Remote Control System equipment. These features are only available when using an AC Transformer equipped with a whistle and bell button.

Activating Proto-Sound 2.0 Conventional Mode Features (AC Operation Only)

Proto-Sound 2.0 features are activated by sequences of Bell and Horn button pushes described below. Please read the full descriptions of each feature before using it. To use these buttons to activate features rather than to blow the horn or ring the bell, you should tap the buttons very quickly with a 1/2-second pause between button presses. You may need to practice your timing to make this work smoothly.

Timing Chart				
Press Horn Short & Firm	1/2 Sec. Pause	Press Bell Short & Firm	1/2 Sec. Pause	Press Bell Short & Firm
Total Time Lapse: 1 1/2 Seconds				

Feature to Be Activated:	Button Code:
Freight Yard Sounds	1 Bell, 2 Whistle/Horn
Fire the Rear Coupler	1 Bell, 3 Whistle/Horn
Fire the Front Coupler	1 Bell, 4 Whistle/Horn
Speed Control On/Off	1 Whistle/Horn, 2 Bells (From Neutral Only)
Lock into a Direction/Unlock	1 Whistle/Horn, 3 Bells
Reset to Factory Defaults	1 Whistle/Horn, 5 Bells (From Neutral Only)

Freight Yard Sounds (FYS) or Passenger Station Announcements (PSA):

Your engine is equipped with a sound package of either freight yard or passenger station sounds that you can play. Each sequence described below will play as long as it is left on, randomly generating sounds, but be sure to allow approximately 30 seconds between the button pushes described below to allow the FYS/PSA sufficient time to run through each sequence.

- To cue the sound system to play the FYS/PSA, quickly but firmly tap the Bell button once followed by 2 quick taps of the Horn/Whistle button while the engine is moving. Tap the buttons quickly but allow approximately ½ second between each press
- Press the Direction button once to stop the engine. This will trigger the first sequence of FYS/PSA. The reverse unit is temporarily disabled so that the train will not move as you use the Direction button to trigger the sounds, and Proto-Sound 2.0 has disabled operator control over the Horn/Whistle and Bell buttons until the full FYS/PSA sequence is complete.
- After waiting about 30 seconds for that sequence to run, press the Direction button again to trigger the second sequence of FYS/PSA.
- After about 30 seconds, press the Direction button again to trigger the third FYS/PSA sequence.
- Again, after allowing about 30 seconds for that sequence to run, press the Direction button one more time to trigger the fourth and final FYS/PSA sequence.
- The FYS/PSA will continue, and within a few seconds, the engine will start and move out on its own at the current throttle setting, in the same direction it was traveling when you began the sequence. Once the bell turns off, the operator regains control of the transformer's Bell and Horn/Whistle buttons and can ring the bell or blow the horn/whistle as usual.

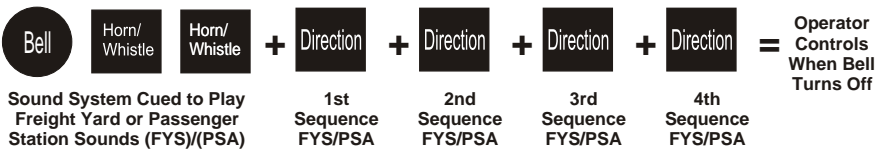

Tips on Using FYS/PSA

- You can terminate FYS/PSA at any time by turning off power to the track for 15 seconds.
- You do not have to be in Forward to use FYS/PSA. At the conclusion of the full sequence, the train will pull away from the station in whatever direction you were going when you activated the feature.
- You can use FYS/PSA even if you are double-heading with another engine. If the second engine is not equipped with Proto-Sound 2.0, you must remember not to leave the throttle at a high voltage level once you have stopped the engine to run the FYS/PSA. Otherwise, the engine without FYS/PSA will begin vibrating on the track as its motors strain to move the train, since they cannot be automatically disabled during the FYS/PSA cycle (or if an original Proto-Sound engine, FYS/PSA are triggered differently and that engine's motor-disable feature will not be active when you run FYS/PSA in Proto-Sound 2.0).
- FYS/PSA can be triggered from Neutral. It will operate the same as if triggered while in motion except that, at the conclusion of the FYS/PSA, the engine will depart in the next direction of travel, as opposed to the direction it was traveling before entering Neutral.

Proto-Coupler™ Operation

This locomotive is equipped with one or more coil-wound Proto-Couplers for remote uncoupling action. Because Proto-Couplers are controlled through the Proto-Sound 2.0 microprocessor, they do not require an uncoupling track section or modification to your layout to function. You can fire a coupler from neutral or while in motion. Use the code shown below (and in the chart on page 7) to fire the coupler(s).

Rear Coupler:

To fire the rear coupler, quickly tap the Bell button once followed by three quick taps of the Horn/Whistle button, allowing approximately ½ second to lapse between each quick button press. The sound of the liftbar and air line depletion will play, and the knuckle will be released.



Front Coupler:

To fire the front coupler (if your engine has one), quickly tap the Bell button once followed by four quick taps of the Horn/Whistle button, allowing approximately ½ second to lapse between each quick button press. The sound of the liftbar and air line depletion will play, and the knuckle will be released.



Speed Control:

M.T.H. engines equipped with Proto-Sound 2.0 have speed control capabilities that allow the engine to maintain a constant speed up and down grades and around curves, much like an automobile cruise control. You can add or drop cars on the run, and the engine will maintain the speed you set.

While the engine is programmed to start with the speed control feature activated, you can opt to turn it off. This means the engine's speed will fall as it labors up a hill and increase as it travels downward. It is also affected by the addition or releasing of cars while on the run. Because the engine will run more slowly at a given throttle voltage when speed control is on than when it is off, you should adjust the throttle to a lower power level for operation with speed control off to avoid high-speed derailments. When speed control is off, the volume will drop to allow for better low voltage operation.

To turn speed control on and off, put the engine in neutral, then quickly tap the transformer's horn/whistle button one time then quickly tap the Bell button two times, allowing approximately ½ second to lapse between each quick button press. Repeat the 1 horn/whistle, 2 bells code to return it to the other condition. You will want to do this during the initial neutral upon start-up if you ever couple this engine to another engine that is not equipped with speed control to avoid damaging the motors in either engine. Each time you shut down the engine completely, it will automatically turn speed control on.



Lock into a Direction:

You can lock your engine into a direction (forward, neutral, or reverse) so that it will not change directions. To do this put the engine into the direction you want (or into neutral to lock it into neutral), run it at a very slow crawl (as slowly as it will move without halting), and quickly but firmly tap the Horn/Whistle button once followed by three quick taps of the Bell button, allowing approximately ½ second to lapse between each quick button press. Two horn/whistle blasts will indicate that the engine has made the change. The engine will not change direction (including going into neutral) until you repeat the 1 horn/whistle, 3 bells code to return the engine to its normal condition, even if the engine is kept without power for extended periods of time.



Reset to Factory Defaults:

To override the settings you currently have assigned to the engine and reset it to its factory defaults, while in Neutral tap the Horn/Whistle button quickly once, followed by five quick taps of the Bell button, allowing approximately ½ second to lapse between each quick button press. Two horn/whistle blasts will indicate that the engine has made the change.



Automatic Sounds:

Certain Proto-Sound 2.0 sound effects automatically play in programmed conventional mode conditions:

- Squealing Brakes play any time the engine's speed decreases rapidly.
- Cab Chatter plays at random intervals when the engine idles in neutral.
- Engine Start-up and Shut-down sounds play when the engine is initially powered on or is powered off for five seconds or more.

Maintenance

Lubricating and Greasing Instructions

The engine should be well oiled and greased in order to run properly. You should regularly lubricate all side rods and linkage components to prevent them from squeaking. Use light household oil and follow the lubrication points marked “L” in Fig 10. Do not over-oil. Use only a drop or two on each pivot point. Please note that the Triplex steam engine has 3 motors and 3 gearboxes. The third motor and gearbox is located in the tender.

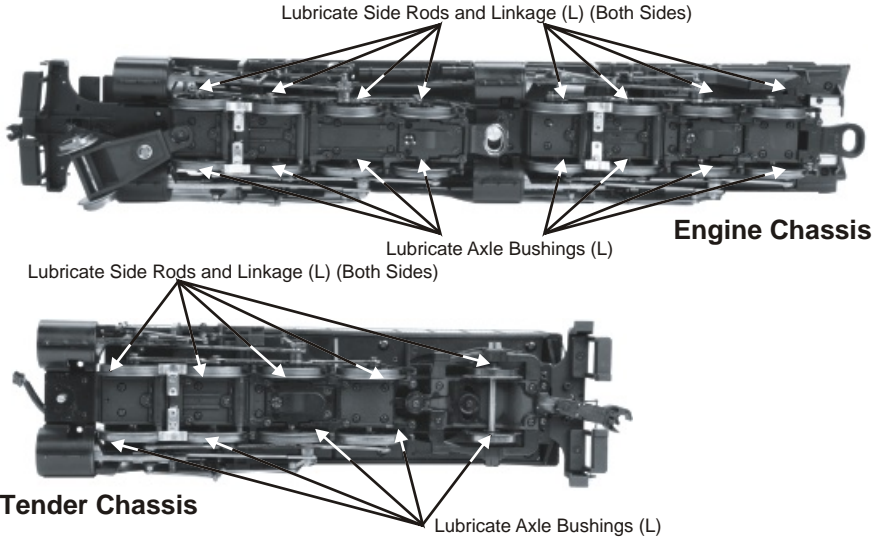

Figure 11: Lubrication Points on the Locomotive and Tender

You should also grease the leading and trailing locomotive truck tongues to enhance their ability to slide on the chassis. Follow the grease points shown above Fig. 12.

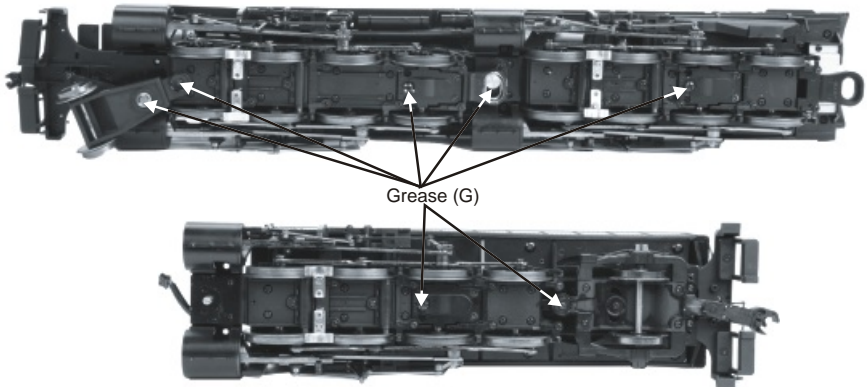

Figure 12: Greasing the leading and trailing

Removing Tender Shell

To remove the tender shell first pull the handrails out of the rear pilot beam. Unscrewing the top of the smokestack will lessen the chance of the smokestack being damaged when the tender is turned upside down.

Then remove the 6 body mounting screws show fig. 11
The tender body can then be separated from the chassis.
To reassemble the tender reverse the step above.

Separating the Body from the Chassis

The locomotive's internal gearing was greased at the factory and should not need additional grease until after 50 hours of operation or one year, whichever comes first. To add grease, remove the grease screws. To add grease to the gearboxes, remove the grease screw from each gearbox and squeeze grease from a tube into the gearbox.

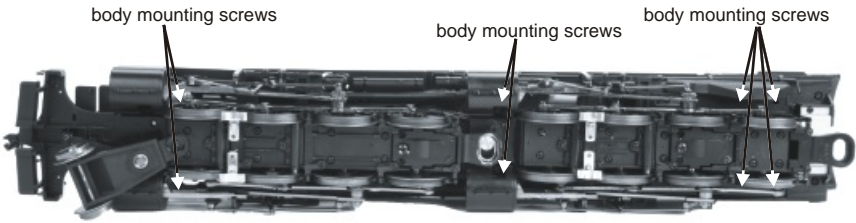

Figure 13a

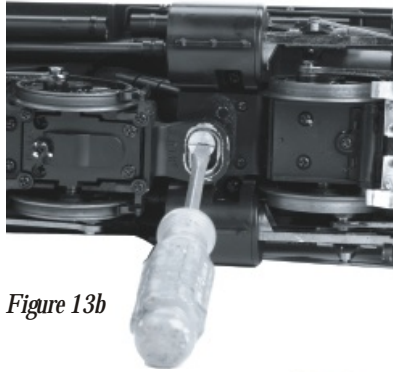

Figure 13b

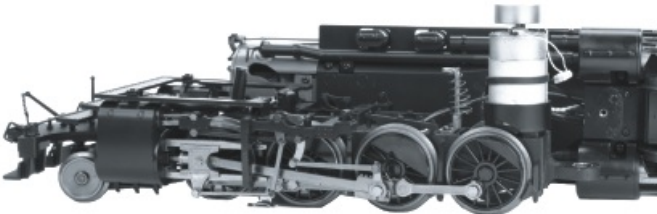

Figure 13c

Traction Tire Replacement Instructions

Your locomotive is equipped with six neoprene rubber traction tires on each rear set of flanged drivers. While these tires are extremely durable, you may need to replace them at some point.

1. Remove the side rods from the wheels in order to slip the new tire over the grooved drive wheel. Make sure to note the position of all rods before removing.
2. Make sure the old tire has been completely removed from the groove in the drive wheel, using a razor blade or small flathead screwdriver to pry away any remains.
3. Slip the new tire onto the wheel. You may find it useful to use two small flathead screwdrivers to stretch the tire over the wheel.
4. If you twist the tire while stretching it over the wheel, you will need to remove and reinstall the tire. Otherwise your engine will wobble while operating.
5. Make sure the tire is fully seated inside the groove. Use a razor blade to trim away any excess tire that doesn't seat itself inside the groove properly.
6. Reinstall the side rods in the same positions as noted. Failure to align rods may cause binding or damage to the drive system.

One set of replacement tires is packaged with your model. Additional sets are available directly from the M.T.H. Parts Department (Order online: www.mth-railking.com, e-mail: parts@mth-railking.com, Fax: 410-423-0009, Phone: 410-381-2500, Mail: 7020 Columbia Gateway Drive, Columbia MD 21046-1532,).

Cleaning The Wheels, Tires, and Track

Periodically check the locomotive wheels and pickups for dirt and buildup, which can cause poor electrical contact and traction and prematurely wear out the neoprene traction tires. Wheels and tires can be cleaned using denatured (not rubbing) alcohol applied with a cotton swab.



To clean the track, use RailKing Track Cleaning Fluid found in Maintenance Kit (30-50010) or denatured (not rubbing) alcohol and a clean rag. Unplug the transformer and wipe the rails of the track, turning the rag frequently to ensure that you are using clean cloth on the rails. Thereafter, keep an eye on the track and clean it when it gets dirty to ensure good electrical contact and to lengthen the life of the tires.

Clean any type of track with this heavy-duty track cleaning block (40-1099). Durably constructed from ABS plastic, the block includes a built-in cleaning pad. For really stubborn track, you can insert sandpaper into the block in just a few quick steps.



Track Cleaning Block (40-1099)



Maintenance Kit (30-50010)

Light Bulb Replacement Instructions

The locomotive and tender lights are controlled by a constant voltage circuit in the engine. They can be removed and replaced when they burn out by removing the boiler's front door.. (Shown below)

You can obtain replacement bulbs directly from the M.T.H. Parts Department (Order online: www.mth-railking.com, e-mail: parts@mth-railking.com, Fax: 410-423-0009, Phone: 410-381-2500, Mail: 7020 Columbia Gateway Drive, Columbia MD 21046-1532,).

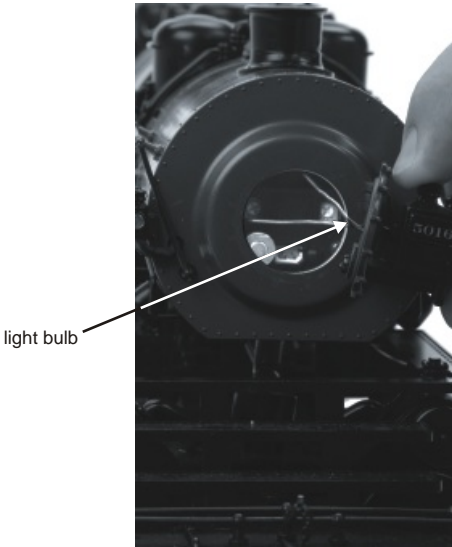

Figure 14

Self Charging Battery Back-up

The special NiCad 2.4v self-charging battery recharges continuously during train operation and should last for up to five years. The battery is a dry battery that should not leak or cause any damage to your engine. Depending upon when your engine was built, it may need to be charged right out of the box. If engine sounds seem distorted or garbled at low voltages or become silent when power from the transformer is turned off, test the battery to determine whether it should be recharged or replaced.

Test: Put the engine in neutral and leave the track voltage at 10-12 volts (high enough for the lights to shine brightly) for 15 minutes.

Recharge: If the sounds are improved at the end of the 15-minute test charge, the battery charge has run down and can be recharged. There are a number of ways you can do this:

- Leave the engine in neutral with track voltage at 10-12 volts for 6-7 hours so the battery can fully recharge (if your engine has a smoke unit, be sure it is turned off).
- Use M.T.H.'s battery recharger (Item No. 50-1019) (sold separately) that plugs into a wall outlet and a special port under the engine to recharge the battery overnight without leaving it on the track.

Replace: If the sounds are not improved at the end of the 15-minute test charge, it is time to replace the battery. Available through M.T.H. Parts: (Item No. 50-1024) AA NiCad Proto-Sound® Battery

DO NOT substitute alkaline batteries for these NiCad batteries. Using alkaline batteries in this system can result in damage to the PS 2.0 circuit board and/or the batteries.

****Do not use alkaline batteries for testing or checking purposes for the 3-Volt PS2 boards. Using alkaline batteries will damage the 3-Volt battery charging circuit.****

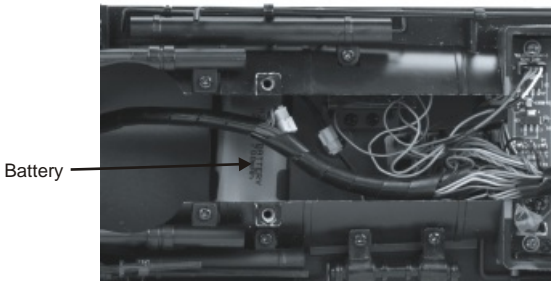

Figure 15: Remove Body (shown on page 19) then replace battery

ProtoSmoke™ Unit Maintenance

This RailKing One-Gauge steam locomotive contains a self-powered smoke unit that outputs smoke through the smokestack on the roof of the engine. The smoke unit is essentially a small heating element and wick that soaks up and then heats a mineral oil-based fluid that emits a harmless smoke. The smoke is then forced out of the stack by a small electric fan. Smoke volume is controlled by the Proto-Sound 2.0 system. With a few easy maintenance steps, you should enjoy trouble-free smoke unit operation for years.

When preparing to run this engine, add 30-40 drops of smoke fluid through the smokestack (see Fig. 16). We recommend M.T.H. ProtoSmoke, Seuthe, LGB, or LVTS fluids. Do not overfill the unit or the fluid may leak out and coat the interior engine components.

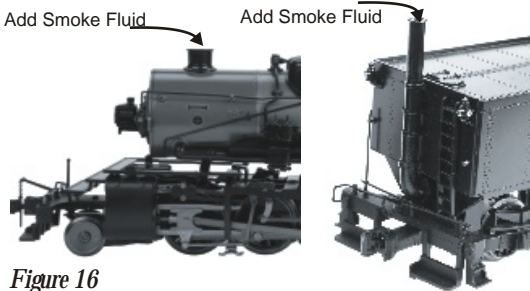

Figure 16

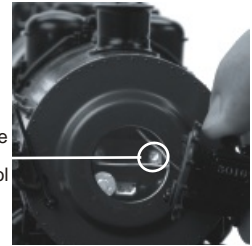

Figure 17

If you choose not to add the fluid (or have already added the fluid but choose to run smoke-free), turn off the smoke unit switch located inside the boiler front door (see Fig. 17). Failure either to add fluid to the unit or to turn it off may damage the smoke unit heating element and/or wick material.

When the smoke output while running the engine begins to diminish, add another 10-15 drops of smoke fluid or turn the smoke unit off.

When storing the unit for long periods of time, you may want to add about 15 drops of fluid to prevent the wick from drying out.

After removing the engine from storage, add another 25 drops of fluid, letting the wick soak up the fluid for 15 minutes prior to operation.

If you experience poor or no smoke output when the smoke unit is on and has fluid, the wicking material inside the smoke unit may need to be replaced. Such a repair requires that the locomotive be returned to an M.T.H. Authorized Service Center.



Steaming Whistle

Add smoke fluid

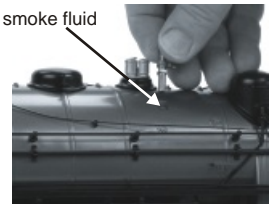

Figure 18

Steaming Whistle

The steaming whistle has its own smoke fluid reservoir. To refill the reservoir gently pull the whistle detail out of the boiler. Apply 8 drops of smoke fluid into the hole. Then gently blow into the hole to breakup any air bubbles that may have formed and replace the whistle detail.

Troubleshooting Proto-Sound® Problems

Although Proto-Sound 2.0 has been designed and engineered for ease of use, you may have some questions during initial operation. The following table should answer most questions. If your problem cannot be resolved with this table, contact M.T.H. for assistance (telephone: 410-381-2580; fax: 410-423-0009; service@mth-railking.com, 7020 Columbia Gateway Drive, Columbia MD 21046-1532).

Starting Up	Remedy
When I first turn the power on, the engine will not begin to run. I have to turn the throttle off and then on again to get the engine to operate.	This is normal behavior. To prevent accidental high-speed start-ups, Proto-Sound 2.0 is programmed to start up in neutral anytime track power has been turned off for several seconds.
Whistle/Horn	Remedy
When I press the whistle/horn button, the bell comes on instead.	Reverse the transformer leads.
I can't get the horn to blow when I press the whistle button.	You may be pressing the button too quickly. Try pressing the whistle/horn button more slowly, taking approximately one full second to fully depress the button.
Bell	Remedy
When I press the whistle button, the bell sounds.	Reverse the transformer leads.
I can't get the bell to ring when I press the bell button.	You may be pressing the button too quickly. Try pressing the bell button more slowly, taking approximately one full second to fully depress the button.
The bell won't work on a separate bell button.	Check the wiring of the separate button.
Coupler	Remedy
When I try to fire the coupler, FYS starts.	You are waiting too long between whistle button presses.
The Proto-Coupler won't let the engine uncouple on the fly.	Try lubricating the coupler knuckle with a dry graphite lubricant. Do NOT use oil.
The coupler does not fire or stay coupled.	The coupler needs to be cleaned. Wipe with denatured alcohol (not rubbing alcohol) and let dry.

Cab Chatter	Remedy
Sometimes the Cab Chatter sounds don't play.	Cab Chatter plays only in neutral at random intervals.
Lock-out	Remedy
I can't get the engine to run after I power up the transformer. It sits	The engine is locked into the neutral position. Follow the procedure in the "Lock into a Direction" section.
The engine won't lock into forward, neutral, or reverse.	Engine speed must be below 10 scale mph (approx. 10 volts or less in conventional mode).
Volume	Remedy
The sounds seem distorted, especially when the whistle or bell is activated.	Proto-Sound 2.0 volume is set too high. Turn the volume control knob on the bottom of the chassis counter-clockwise to reduce the volume.
Battery	Remedy
The engine will not leave the initial neutral setting.	Check to be sure the battery is installed and fully charged. See the "Self-Charging Battery Back-Up" section.
I get no sounds when the engine shifts between directions.	The battery may be dead or need to be charged. See the "Self-Charging Battery Back-Up" section.
After I turn off my transformer, my engine continues to make sounds before quitting.	Proto-Sound 2.0 is designed to continue to sound for a few seconds after power to the track has been shut off.
FYS/PSA	Remedy
The FYS/PSA sounds occasionally repeat themselves.	Proto-Sound 2.0 has a built-in random number generator that randomly selects each sound clip to play. Because there are a limited number of sound clips available in each FYS/PSA sequence, it is probable that some of these sound clips will be repeated from time to time.

FYS/PSA	Remedy
Once in FYS/PSA, the engine doesn't go into reverse.	So that FYS/PSA effects can be as realistic as possible, Proto-Sound 2.0 disables the reversing unit whenever FYS/PSA is enabled. This way the engine remains still at its stop as the operator cycles through the FYS/PSA sequences.
When the FYS/PSA enters its last sequence the bell automatically comes on.	FYS/PSA is programmed to start ringing the bell at that point. After approximately 12 seconds it will automatically turn off.
When FYS/PSA is enabled, pressing the whistle and bell buttons has no effect.	Because FYS/PSA must control various effects in each sequence, Proto-Sound 2.0 takes control of these sound effects until you exit
I push the direction button but the next sound clip in the sequence does not play or the engine does not come out of FYS/PSA after fourth press of the direction button.	Each FYS/PSA clip must play for approx. 30 seconds before FYS/PSA will advance to the next step in the FYS/PSA cycle. Wait at least 30 seconds in each FYS/PSA sound clip before pressing the direction button.

Transformer Compatibility and Wiring Chart

Proto-Sound 2.0 is designed to work with most standard AC transformers. The chart below lists the many compatible transformers. Note that many of the operational commands described in these instructions require a bell button, so if your transformer does not have its own bell button, you should consider adding one to get the full benefit of the system. In addition, the chart details how the terminals on these transformers should be attached to your layout.

RECOMMENDED AC TRANSFORMERS					
Transformer Model	Center Rail	Outside Rail	Min/Max. Voltage	Power Rating	Transformer Type
MTH Z-500	Red Terminal	Black Terminal	0-18v	50-Watt	Electronic
MTH Z-750	Red Terminal	Black Terminal	0-21v	75-Watt	Electronic
MTH Z-1000	Red Terminal	Black Terminal	0-21v	100-Watt	Electronic
MTH Z-4000	Red Terminal	Black Terminal	0-22v	390-Watt	Electronic
Lionel 1032	U	A	5-16v	90-Watt	Standard
Lionel 1032M	U	A	5-16v	90-Watt	Standard
Lionel 1033	U	A	5-16v	90-Watt	Standard
Lionel 1043	U	A	5-16v	90-Watt	Standard
Lionel 1043M	U	A	5-16v	90-Watt	Standard
Lionel 1044	U	A	5-16v	90-Watt	Standard
Lionel 1053	U	A	8-17v	60-Watt	Standard
Lionel 1063	U	A	8-17v	60-Watt	Standard
Lionel LW	A	U	8-18v	75-Watt	Standard
Powermaster	U	A	8-18v	135VA	Electronic
All-Trol	Left Terminal	Right Terminal	0-24v	300-Watt	Electronic
Dallee Hostler	Left Terminal	Right Terminal			Electronic
Lionel LW	A	U	8-18v	75-Watt	Standard
Lionel KW	A or B	U	6-20v	190-Watt	Standard
Lionel MW	Outside Track Terminal	Inside Track Terminal	5-16v	50V.A.	Electronic
Lionel RS-1	Red Terminal	Black Terminal	0-18v	50V.A.	Electronic
Lionel RW	U	A	9-19v	110-Watt	Standard
Lionel SW	U	A	Unknown	130-Watt	Standard
Lionel TW	U	A	8-18v	175-Watt	Standard
Lionel ZW	A,B,C or D	U	8-20v	275-Watt	Standard
Lionel Post-War Celebration Series ZW	A,B,C or D	Common	0-20v	135/190 Watt	Electronic

* Conventional Mode Only

Recommended DC Power Supplies

Proto-Sound 2.0 is designed to work with most standard DC power supplies and AC transformers. The following charts lists the recommended DC and AC transformers. Note that many of the AC operational commands described in these instructions require a bell button, so if your AC transformer does not have its own bell button, you should consider adding one to get the full benefit of the system. In addition, the chart details how the terminals on these transformers should be attached to your layout. DC transformers employing PWM (pulse width modulation) should not be used with the separately sold DCS system.

Transformer Model	Min/Max. Voltage	Power Rating	Transformer Type
MRC Controlmaster 20	0-20v	100 Watt	Electronic
PH Hobbies PS5	0-20v	100 Watt	Electronic
PH Hobbies PS10G	0-20v	180 Watt	Electronic
BridgeWorks Magnum-15	0-24v*	300 Watt	Electronic
BridgeWorks Magnum 200	0-24v*	300 Watt	Electronic
BridgeWorks Magnum 400	0-24v*	300 Watt	Electronic
BridgeWorks Magnum 1000	0-24v*	300 Watt	Electronic
LGB Jumbo 50101	0-24v*	240 Watt	Electronic

*Use 22 volts maximum track voltage when operating a MTH Locomotive equipped with Proto-Sound, Loco-Sound, or Proto-Sound 2.0

Additional Features Accessible With The DCS Remote Control System

(Additional equipment required)

While conventional mode operation of a Proto-Sound 2.0 engine yields wonderfully realistic sound and several train control features, command mode operation allows the user to access a world of command functions never before accessible to O Gauge railroaders. With the addition of the DCS Remote Control System (including a DCS remote handheld and Track Interface Unit) users gain many advanced features, including:

- DCS Proto-Speed Control - Establishes desired locomotive speed in scale miles per hour increments via a thumbwheel control and allows operator to set maximum speed and acceleration/deceleration rates
- ProtoSmoke® Variable Output Control - Controls how much smoke each engine outputs and matches smoke to locomotive speed
- Locomotive Lighting Control - Controls locomotive headlights, marker and interior lights, beacon lights, ditch lights, and MARS lights
- Emergency Stop-Single button push stops all Proto-Sound 2.0 trains but does not turn off the power
- One Touch Global Mute/UnMute-Single button mutes or unmutes all DCS-controlled locomotives' user-defined actions, including sound, lights, and smoke
- Proto-Dispatch Operation-Public Address-like feature allows users to speak through locomotive speaker during operation
- Proto-Cast-Allows users to play audio recordings through locomotive speaker during operation
- Proto-Doppler Sound Effects Set Up-Users can configure locomotive for Doppler Operation, including setting distance points for Doppler start, repeat, and stop modes
- Independent Volume Control of Engine Sounds, Bell, Horn & Whistle for each Locomotive
- Control up to 50 different DCS-Equipped Locomotives at one time with multiple TIUs
- Proto-Effects™ Set Up-User can select individual Proto-Effects™ operations to be active or inactive, including cab chatter, train wreck sounds, coupler sounds, Direction Control Set Up-User can set initial individual start-up direction (start in forward or reverse) for double-heading operations
- Locomotive Consist Set-up-User can determine locomotive values for consist make-ups, allowing multiple locomotives belonging to a consist to operate together

Service & Warranty Information

How to Get Service Under the Terms of the Limited One-Year Warranty

When you suspect an item is defective, please check the operator's manual for standard operation and troubleshooting techniques that may correct the problem. Additional information may be found on the M.T.H. Website. Should you still require service, follow the instructions below to obtain warranty service.

First, e-mail, write, call or fax M.T.H. Electric Trains or a M.T.H. Authorized Service Center (ASC) in your area to obtain Repair Authorization. You can find the list of ASCs on the M.T.H. Website, www.mth-railking.com. Authorized Service Centers are required to make warranty repairs on items sold *only* from that store; all other repairs may-- or may not be done at the store's own discretion. If you did not purchase the item directly from the ASC, you will need to select a National Authorized Service Center (NASC) or contact M.T.H. Electric Trains directly. NASC Dealers are compensated by M.T.H. to perform warranty service for any customer whose repair qualifies for warranty service. A list of NASC retailers can be located on the M.T.H. Website or by calling 410-381-2580. Should the warranty no longer apply, you may choose either an ASC or NASC retailer to service your M.T.H. Product. A reasonable service fee will be charged.

CAUTION: Make sure the product is packed in its original factory packaging including its foam and plastic wrapping material to prevent damage to the merchandise. There is no need to return the entire set if only one of the components is in need of repair *unless otherwise instructed by the Service Center*. The shipment must be prepaid and we recommend that it be insured. A cover letter including your name, address, daytime phone number, e-mail address (if available), Return Authorization number (if required by the service center, a copy of your sales receipt and a full description of the problem must be included to facilitate the repairs. Please include the description regardless of whether you discussed the problem with a service technician when contacting the Service Center for your Return Authorization.

Please make sure you have followed the instructions carefully before returning any merchandise for service. Authorized M.T.H. Service Centers are independently owned and operated and are not agents or representatives of M.T.H. Electric Trains. M.T.H. assumes no responsibility financial or otherwise, for material left in their possession, or work done, by privately owned M.T.H. Authorized Service Centers.

If you need assistance at any time email MTH Service at service@mth-railking.com, or call 410 381-2580.

Limited One-Year Warranty

All M.T.H. products purchased from an Authorized M.T.H. Retailer are covered by this warranty. See our Website to identify an Authorized M.T.H. Retailer near you.

M.T.H. products are warrantied for one year from the date of purchase against defects in material or workmanship, excluding wear items such as light bulbs, pick-up rollers, batteries, smoke unit wicks, and traction tires. We will replace or credit (at our option) any defective item with a manufactured suggested retail price of \$279.95 or less (excluding all motive power and electronic items), if the item is returned to an M.T.H. Authorized Service Center (ASC) or M.T.H. National Authorized Service Center (NASC) within one year of the original date of purchase. For any item with an MSRP greater than \$279.95 (including all motive power and electronics), We will repair, replace or credit (at our option) the defective item without charge for the parts or labor, if the item is returned to an M.T.H. Authorized Service Center (ASC) or M.T.H. National Authorized Service Center (NASC) within one year of the original date of purchase. This warranty does not cover damages caused by improper care, handling, or use. Transportation costs incurred by the customer to ship the product for warranty service are not covered under this warranty.

Items sent for repair must be accompanied by a return authorization number, a description of the problem, and a copy of the original sales receipt from an Authorized M.T.H. Retailer stating the date of purchase. If you are sending this product to an Authorized Service Center, contact that Center for their return authorization.

This warranty gives you specific legal rights, and you may have other rights that vary from state to state. Specific questions regarding the warranty may be forwarded to M.T.H. directly

Service Department
M.T.H. Electric Trains
7020 Columbia Gateway Drive
Columbia MD 21046-1532
410-381-2580
service@mth-railking.com



**2-8-8-2 Triplex
Instructions for
Packing and Unpacking**

It is recommended that you review all these instructions before removing the engine or tender from the poly foam container.

www.mthtrains.com

Table of Contents

Opening the Packaging.....	3
Removing Engine from the Polyfoam.....	4
Unpacking the Engine.....	4
Removing the Tender from the Polyfoam.....	7
Unpacking the Tender.....	8
Repacking the Engine.....	9
Repacking the Tender.....	12
Assemble the Packing Materials.....	14

CAUTION: This engine is heavy and contains many delicate parts. Do not drop the packaging when it contains the engine or tender. Pick a suitable working space with sufficient room to maneuver the engine and packaging. Be careful of the anchor studs protruding from the bottom of the shipping frames. The ends can scratch and mar most unprotected surfaces.

Tools Required:

- #2 Phillips Screwdriver
- 7mm wrench or deep socket
- 8mm wrench or deep socket
- Adjustable pliers
- Knife capable of cutting packaging tape.



Opening the Packaging

1. Remove the shipping carton
2. Remove the plastic bag liner
3. The easiest way to remove the color gift box is by opening the flaps on both ends of the box. Gently stand the box on one end slid the gift box upward. (See Fig 1.)
4. Place the polyfoam container on a flat solid surface with the top label facing upward.
5. Cut the packaging tape at the seam completely around the circumference of the polyfoam container.
6. Lift the lid portion of the polyfoam container and set it aside.



Figure 1

Removing the Engine from the Polyfoam

The engine should be removed before the tender. The tender will then act as ballast in the in the polyfoam making easier to remove the engine.

1. Remove the engine from the polyfoam container by grasping the metal shipping frame and lifting as shown in Fig. 2. **Do not lift the engine using the ribbons.**



Figure 2

2. With the metal shipping frame attached set the engine on flat work surface as shown in Fig. 3.

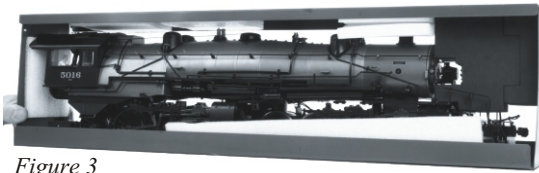

Figure 3

Unpacking the Engine

When unpacking the engine follow the steps below to avoid damaging your engine during the unpacking process.

1. Remove the 4 screws that secure the top panel of the shipping frame. As shown in Fig. 4.



Figure 4

Remove Screws

2. Pull the front end of the shipping frame forward and remove the gray from around the headlight. As shown in Fig. 5.

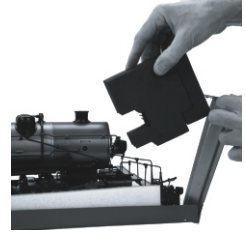

Figure 5

3. With the engine still in the shipping frame lay the engine on its side as shown in Fig. 6

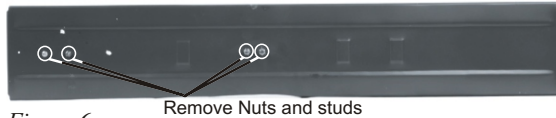

Figure 6

4. Using the 7mm and 8mm wrenches, remove the nuts from the studs on the bottom of the shipping frame. (Fig. 6)
5. Slide the shipping frame over the studs to remove it from the engine
6. Remove the 4 foam packing pieces as shown in Fig. 7.

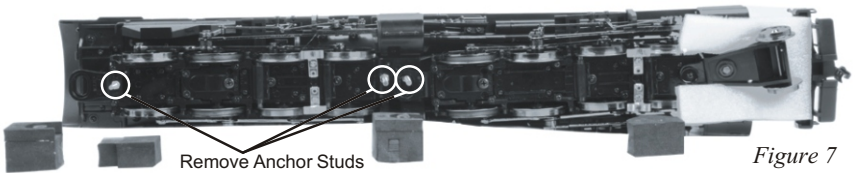

Figure 7

7. Remove the anchor studs from the bottom of the engine chassis. (Fig. 7) The anchor studs should be hand tight and be able to be moved by turning them with your fingers. However, if mechanical assistance is required to remove the anchor studs, using the adjustable pliers to grasp the anchor studs in the center section where the threads do not come in contact with the chassis or the locking nuts, will be helpful in removing the anchor studs.
8. Install the pivot screw that is supplied in the packaging to connect the fixed chassis and the articulated chassis. As shown in Fig 8-9.



Figure 8

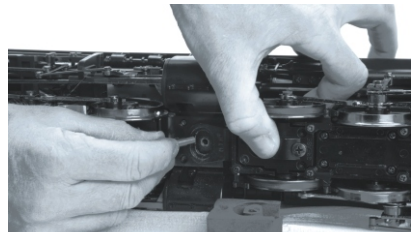

Figure 9

9. The engine can now be placed on the track. When lifting or carrying the engine, always grasp the engine under both sets of driving wheels. Do not lift the engine by grasping any of the body parts, such as the boiler, the cab or the pilot. As shown in Fig. 10-11.



Figure 10

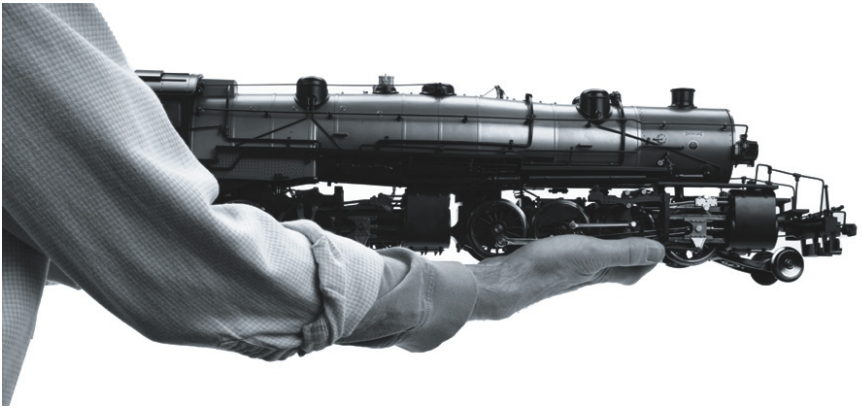

Figure 11

Removing the Tender from the Polyfoam

1. Remove the foam blocks shown in Fig 12.

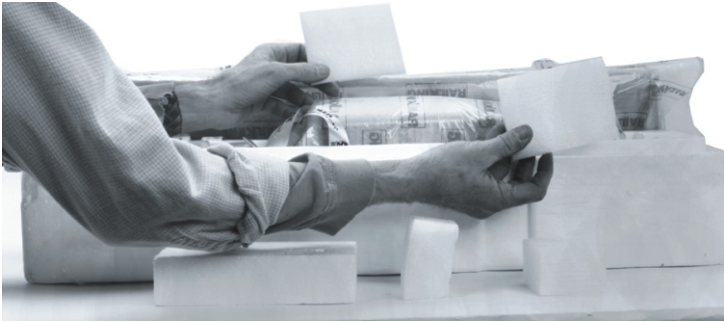

Figure 12

2. Lift one end of the tender and shipping frame assembly using one of the ribbons to the point where you can grasp the underside of the shipping frame with your hand and lift it out of the polyfoam container. (Fig. 13)



Figure 13

3. Lay the tender shipping frame assembly on it side as shown in Fig. 14.



Figure 14

Unpacking the Tender

When unpacking the tender follow the steps below to avoid damaging your tender during the unpacking process.

1. Remove the nuts from the anchor studs on the bottom of the shipping frame. As shown in Fig. 15.

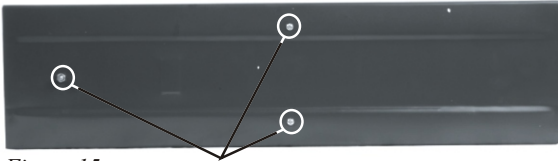

Figure 15 Remove the nuts

2. Slide the brace off of the studs.
3. Remove the foam blocks shown in Fig 16.
4. Remove the anchor stud near the drawbar pin from the tender chassis As shown in Fig. 17.

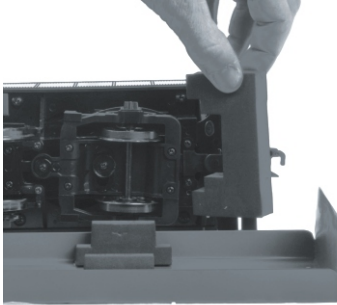

Figure 16

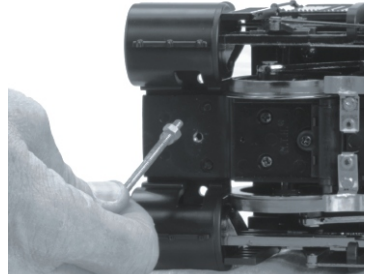

Figure 17

5. Remove the screws shown in the picture that attach the U-shaped brackets to the shipping frame. As shown in Fig 18-19.
6. Remove the U-shaped brackets from the tender chassis
7. The tender can now be placed on the track and connected to the engine.

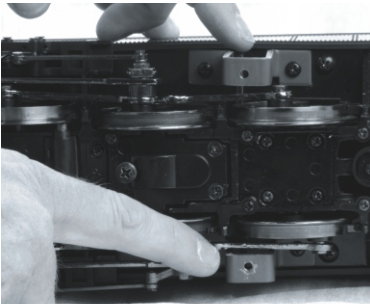

Figure 18



Figure 19

Repacking the Engine

When repacking the engine in the shipping frame and packaging. Follow the direction below to insure the engine is properly protected.

1. If the top panel of the shipping frame is attached to the shipping frame, it must be removed before the engine can be placed in the shipping frame.
2. Remove the pivot screw from the main chassis
3. Insert a 5mm stud into the threaded hole where the pivot screw was removed.
4. Insert the 2nd and third studs.



Figure 20

5. Insert the foam blocks under the chassis as shown in Fig. 20.
6. Insert the foam block between the boiler and the chassis as shown in Fig. 21-22.

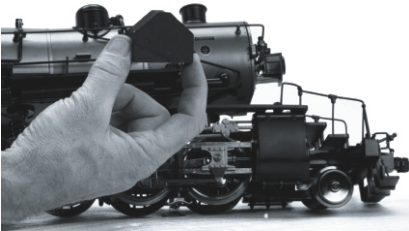

Figure 21

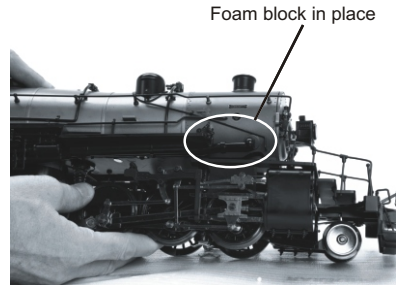

Figure 22

7. Set aside the white foam panels from the shipping frame.
8. Lay the engine on its side as shown in Fig. 23.



Figure 23

9. Attach the shipping frame to the engine by insert the studs through the appropriate holes in the shipping frame.
10. Install the retaining nut on the rear most studs. Do not tighten the nut yet.

11. Set the engine and shipping frame upright as shown in Fig. 24.
12. Slide the white foam strips into the gap between the sides of the shipping frame in the areas of the drive wheels and the cylinders (Fig. 24.)

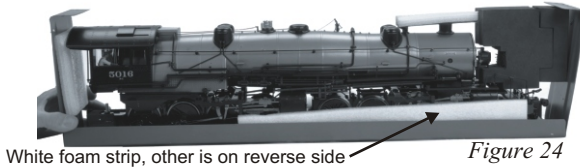

13. Roll engine and the shipping frame on to the side as shown in Fig. 25.



14. Install the remaining nuts on the anchor studs.
15. Tighten all of the nuts on the anchor studs.
16. Install the anchor stud and washers in the location under the rear of the cab as shown in Fig. 26-29.
17. Reference the pictures for the correct location of the washers. The washers are different sizes.

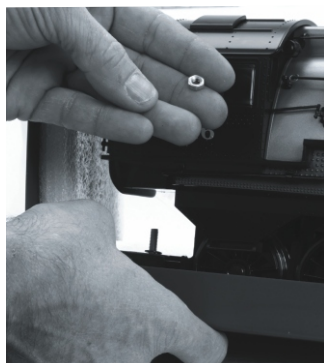
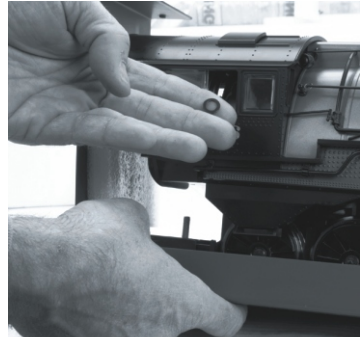
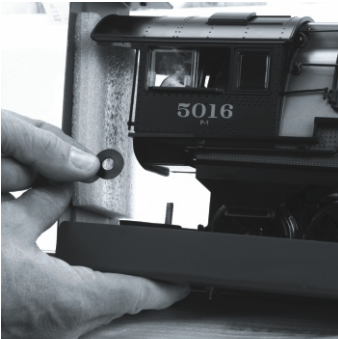

Figure 28

Figure 29

18. Insert the black foam block in front of the smokebox, around the headlight as shown in Fig. 30.

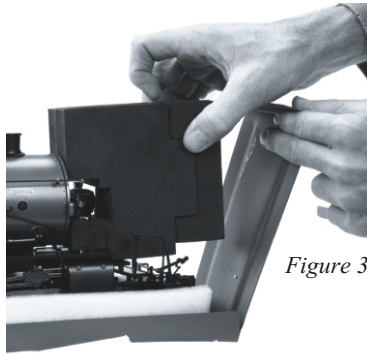

Figure 30

19. Reattach the top panel of the shipping frame using the 4 screws supplied. Do not fully tighten any of the screws until all 4 have threaded into the holes. As shown in Fig. 31.

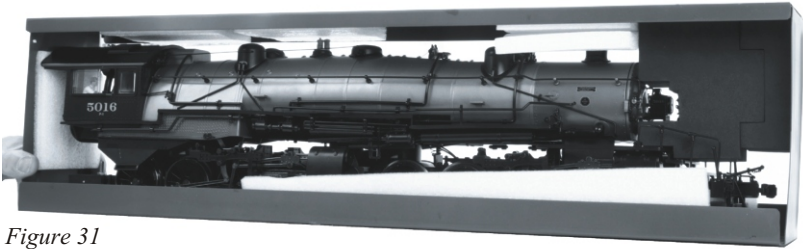

Figure 31

20. Wrap the Engine and Shipping frame in the wrapping paper and plastic wrap provided. As shown in Fig. 32.



Figure 32

Repacking the Tender

When repacking the tender in the shipping frame and packaging. Follow the direction below to insure the tender is properly protected.

1. Insert the front anchor stud into the tender chassis.
2. Install the 2 U-shaped brackets onto the bottom of the tender chassis using the mounting holes in the floor. Make sure that the notches in the sides of the bracket face toward the inside of the tender. (Fig. 33)

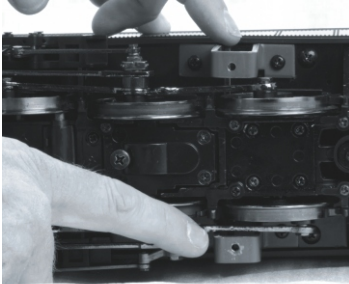

Figure 33

3. Insert the foam block between the trailing truck and the tender pilot as shown in Fig. 34.

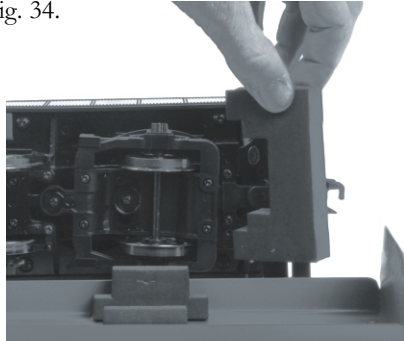

Figure 34

4. Apply the foam block over the anchor stud as shown in Fig. 35.
5. Attach the shipping frame to the tender by inserting the anchor stud through the appropriate hole in the shipping frame.
6. Put the nut on the anchor studs, but do not tighten the nets yet.

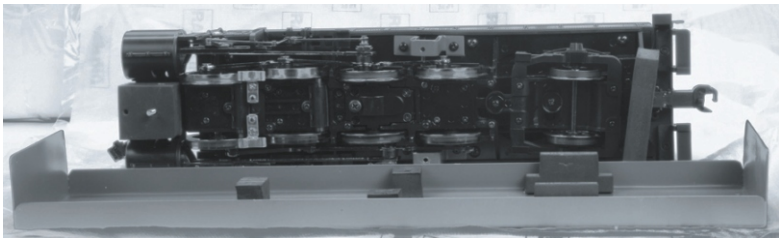

Figure 35

7. Insert one of the small rubber blocks between the U-shaped brackets and the shipping frame and insert the screw into the bracket, but do not completely tighten it yet. As shown in Fig. 36-39.
8. Insert the other small rubber blocks between the U-shaped brackets and the shipping frame and insert the screw.
9. Now tighten both screws.
10. Now tighten the nut on the anchor stud. (Fig. 40.)
11. Wrap the tender and shipping frame with the supplied wrapping paper and plastic wrap.
12. Place the tender and shipping frame assembly in the poly foam container.
13. Insert the white foam panels between the sides of the tender and the polyfoam container.
14. Make sure that the edges of the white foam panels are lower than the upper edge of the polyfoam contain or the polyfoam lid will not fit properly.

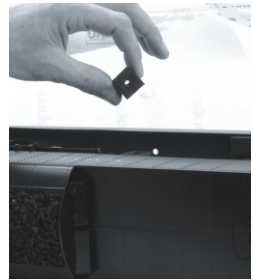

Figure 36



Figure 37



Figure 38

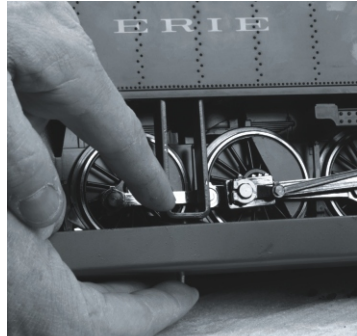

Figure 39

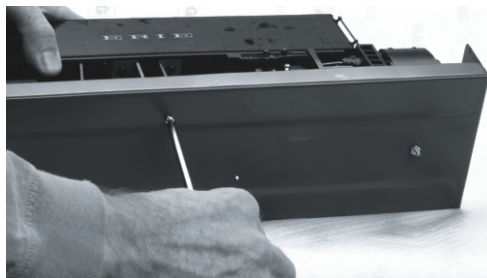

Figure 40

Assemble the Packing Materials

Follow the below instruction to be sure that the packaging materials are assembled properly.

1. Place the polyfoam lid on the polyfoam base.
2. Make sure that the lid fits tight to the base properly without any gaps and is not hung up on a part of the engine, the tender or one of the parts contained in the packaging.
1. Apply a band of packaging tape to the perimeter of the polyfoam container at the location of the seam.
2. Slide the polyfoam container into the color gift box.
3. Gently stand the entire package on end as shown in Fig. 41.
4. Slide the plastic bag over the color gift box as shown in the picture. As shown in Fig. 42.
5. Slide the shipping carton over the color gift box.
6. Place the cardboard filler over the end of the color gift box.
7. Close the end flaps of the shipping carton and seal with packaging tape.
The finished packaging shown in Fig. 43.



Figure 41



Figure 42



Figure 43