



MTH F-3 DIESEL ENGINE OPERATING INSTRUCTIONS



Thank you for purchasing the MTH Electric Trains F-3 diesel locomotive. This 1/4" scale reproduction of the famous F-3 A-B-A locomotive consist measures over 39" in length and weighs over 11 pounds. Despite its scale size, the locomotive is capable of operating on O-31 3-rail track with any compatible AC transformer (see the chart on page 33 for a complete list of compatible transformers and wiring instructions) and is completely compatible with most other 3-rail locomotives, rolling stock and accessories.

The locomotive is equipped with several deluxe features that are simple and fun to operate. Each feature is described among the following pages which should be read before the engine is operated. For those of you who can't wait to get started, the *Quick Start Basic Operating Instructions* found on Pages 3 and 4 should be read so that you understand the basics of the operating system. Please note that some features are only found in the ProtoSound® models and are marked as such. Features not marked as ProtoSound features are available in all models.

PREVIEW LINE

Table Of Contents

QUICK START - BASIC OPERATION	3
PROTOSOUNDS® OPERATING INSTRUCTIONS	4
DCRU® Reverse Unit Operation(All 3-Rail Models)	5
Horn Operation	5
Bell Operation	5
ProtoCoupler® Operation	6
Squeaking Brake Sounds	7
Tips On Using Squeaking Brakes	8
Passenger Station Sounds (PFA)	9
Tips On Using The Passenger Station Sounds	13
Self-Recharging Battery Backup System	15
Replacing The Battery	15
ProtoSound® Volume Adjustment	16
USING "RESET" TO PROGRAM PROTOSOUNDS™	17
Entering RESET Options	17
Setting The Engine Volume	18
Programming For A Separate Bell Button Controller	19
Programming For Squeaking Brake Operation	19
Programming For Horn In Neutral Operation	20
Programming For Cab Chatter Sounds	21
Programming For ProtoCoupler Operation	22
Programming For PFA Operation	22
Activating Reverse Unit Lock-Out Control	23
Resetting All ProtoSound® Options To Factory Defaults	24
Reverse Unit Lockout Control Functions	25
Locking The Engine Into Forward or Reverse	25
Unlocking The Engine	25
Locking The Engine Into Neutral	25
OIL & LUBRICATION INSTRUCTIONS	27
TRACTION TIRE REPLACEMENT INSTRUCTIONS	28
LIGHT BULB REMOVAL & REPLACEMENT	29
TROUBLE SHOOTING PROTOSOUND® PROBLEMS	30
ProtoSound® RESET Feature Chart	32
Transformer Wiring Chart	33
O-31 OPERATION	34
SERVICE AND WARRANTY INFORMATION	40
HOW TO GET SERVICE	40
LIMITED ONE YEAR WARRANTY	40

WARNING:

When using electrical products, basic safety precautions should be followed including the following:

- Read this and all related manuals (transformer/power supply, locomotive, etc.) thoroughly before using this device.*
- This device is not recommended for children under 8 years of age without adult supervision.*
- MTH recommends parents examine the toy transformer used to power this device periodically for conditions that may result in the risk of fire, electric shock, or injury to persons, such as damage to the primary or output cord, plug blades, housing or other parts (including proper functioning of the circuit breaker), and that, in an event such conditions exist, the transformer should not be used until properly repaired.*

QUICK START - BASIC OPERATION

The MTH F-3 contains state-of-the art electronics with several built-in automatic features for incredibly realistic operation. Despite these advanced features, the F-3 is easy to operate with any compatible standard AC transformer (see the compatibility chart on page 33). The F-3 locomotive is controlled by a ProtoSound® DCRU® electronic reverse unit. The reverse unit operates in the same manner that all reverse units function by using forward, neutral and reverse states that are entered each time the throttle is turned on and off or by using the transformer direction switch (if so equipped).

The reverse unit is designed to ignore dirty track, dead spots on switches or minor short circuits without disrupting the engine operation, even at slow, prototypical speeds. Once the engine is placed on the track, the throttle on the transformer can be advanced. You will see that only the engine's

AB SETS
Plug wire harness from powered A unit into non-powered B unit.

AA SETS
Plug wire harness from powered A unit into powered A unit in order to operate directional headlights and coil couplers

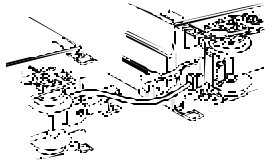

ABA SETS
Plug wire harness from powered A unit into non-powered B unit. Then plug wire harness from non-powered B unit into non-powered A unit in order to operate directional headlights and coil couplers in the non-powered

Figure 1: Plugging In the ProtoSound® Cable Harness

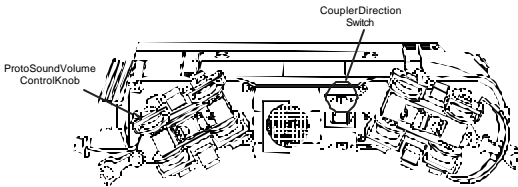

Figure 2: Locating The Proto-Coupler® Selection Switch

lights come on and that only two dings of the ProtoSound bell occur followed by the diesel start-up sounds (on ProtoSound equipped

3-rail models). The engine does not run. This is known as the RESET state and is explained in more detail beginning on Page 4. The ProtoSound® DCRU®

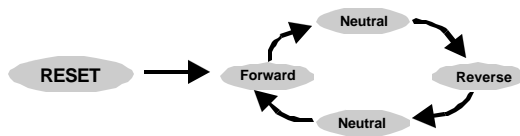

Figure 2: DCRU™ Cycle Phases

will not power the motors until the throttle is turned OFF and then ON again. At this point, the engine will now function just like any other electronic or mechanical E-unit.



PROTOSOUNDS® INSTRUCTIONS

The MTH ProtoSound® digital sound and train control system provides the operator with unprecedented realistic operation on your model railroad. In addition to actual diesel engine, CD-equivalent 16-bit digital sounds, you get the following features:

- * **Built-In DCRU Reverse Unit** * **Authentic Diesel Engine Horn Sound** *
- Authentic Diesel Engine Bell Sound** * **Squeaking Brake Sound** * **Passenger Station Sounds** * **Operating Remote Controlled Proto-Coupler®** *
- Self-Recharging Battery Back-Up System With Automatic Battery Shut-Off** *
- Remotely Controlled Reverse Unit Lock-Out** * **Remotely Adjustable Diesel Engine Volume** * **Upgradeable Microprocessor Options** * **Authentic Diesel Engine Start Up & Shut Down Sounds** * **Random Selection of Four "Cab Chatter" Radio Transmission Sound Clips** * **Authentic Diesel Shut Down Sounds**

Each feature is described among the following pages. Though the system is easy to use, we encourage you to read the instructions thoroughly.

PROTOSOUND® DCRU® REVERSE UNIT

As mentioned in the Basic Operating section, the engine is controlled by a ProtoSound® DCRU® reverse unit that contains the standard forward-neutral-reverse states found on most reverse units. However, as described earlier, when power is first applied to the track, the reverse unit begins in RESET or what seems like a neutral state. Power must be interrupted again to get the locomotive to enter the forward state. It is this first RESET state that gives ProtoSound® its unique, remote controlled functions. The system will enter RESET whenever power to the track is off for three or more seconds. NEUTRAL will be referred to as the state between Forward and Reverse.

ProtoSounds® is equipped with a microprocessor, that, depending on the amount of memory it is allotted, allows the user to utilize several remotely activated functions. In the simplest terms, ProtoSounds® has its own "Computer" controlling these functions. In fact, the power of this microprocessor is the same as that of a 286 desktop computer! In order to access many of these remotely controlled functions, the user must be in the RESET state to do so. RESET is entered anytime power to the locomotive has been off for more than 3 to 5 seconds. When the engine first enters

RESET, the microprocessor initiates a system check to determine if the system, transformer and engine are operating correctly. This takes approximately 2.2 seconds during which you will hear the engine's startup sounds begin. In order for ProtoSounds to properly initiate the system check, do not advance the transformer throttle past 10 volts when you first enter RESET, wait for the diesel startup sounds to begin and then slowly turn the transformer throttle to the off position and then back on again to enter the forward phase. Interrupting the power too quickly may cause the system to re-enter RESET (signaled by two dings of the bell). Should this happen, wait longer before interrupting the power to enter the Forward phase.

ProtoSounds® comes with several programmable functions, including Engine Volume Adjustment, Separate Bell Button Operation (pre-programmed at the factory), Cab Chatter On/Off Control, ProtoCoupler On/Off Control and Horn-In-Neutral Operation. Each of these features are described in more detail later. You will notice that when in RESET, your engine will not respond to the whistle button with a horn blast or continuous bell ringing. In fact, when in RESET and the whistle button is depressed, only one single bell chime will be heard each time the whistle button is pressed. If you don't want to configure or change your locomotive using any of these programmable features, simply leave RESET and wait 2.2 seconds before interrupting the power to put the engine in forward. After you leave RESET, your engine will operate normally in all the direction states of forward, neutral and reverse.

HORN OPERATION

Your MTH F-3 ProtoSound-equipped engine is equipped with a digital recording of a diesel horn. The horn sound can be activated anytime the engine is in forward or reverse by pressing the whistle button on your transformer. The horn will continue to blow as long as the whistle button is depressed. The horn will not function in RESET and must be configured through a RESET option to allow the horn to work when the engine is in neutral. See page 17 for information on horn programming in the *Using RESET To Program ProtoSounds®* section of this manual.

BELL OPERATION

Your MTH F-3 ProtoSound-equipped engine is equipped with a digital recording of an actual diesel bell. Unlike previous versions of ProtoSounds, the bell can be turned on or off with any separate bell button, like the

Lionel® Railsounds® No. 5906 Bell Button, by simply pushing the button. If you don't have a separate bell button, the bell can be controlled through your transformer's whistle button whenever the engine is in NEUTRAL. The bell will never ring continuously in RESET (Remember NEUTRAL is the state between Forward and Reverse). Once the bell is turned on, it will continue to ring when the engine is cycled into forward or reverse until you press the bell button or re-enter NEUTRAL and turn the bell off with the whistle button.

In fact, because of ProtoSounds® state-of-the-art design, the microprocessor remembers its last command. Therefore, unless you turn the bell off before you quit running your train, the next time you run the engine, the bell will come on. No matter whether you come back an hour later or a year later, the bell will begin chiming once the engine enters one of the three directional states.

To turn the bell on using the transformer's whistle button, turn on power to the track and cycle the engine into NEUTRAL. Turn the throttle to 8 volts or less (any higher voltage will arm the ProtoCoupler) and press the whistle button. The bell should begin chiming. To turn the bell off, press the whistle button again. If you want to keep the bell on while running the engine, simply interrupt the power with the transformer throttle or the transformer directional switch and enter forward or reverse.

PROTO-COUPLER® OPERATION

Your MTH F-3 ProtoSound-equipped locomotive has two coil-wound Proto-Couplers® for remote uncoupling action. The couplers are mounted on the leading power trucks of each A Unit. Because the Proto-Coupler® is controlled through ProtoSound's microprocessor, it doesn't require an uncoupling track section or modification to your layout to function. The three simple steps below are required to operate the coupler.

1. Put your engine in NEUTRAL and turn the throttle all the way up.
2. Press the transformer whistle button to "Arm" the coupler. (You will hear a "Clank")
3. After arming the coupler, press the whistle button again to open the coupler.

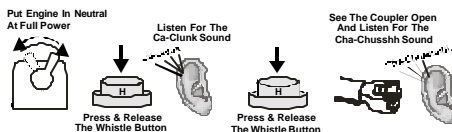

When the knuckle fires open you will hear the buzzing of the coil energizing and the sound of the air lines coming apart. It can best be described as a CHA-CHUSHHH sound. The coupler doesn't have to be fired in NEUTRAL. Once the coupler is armed it can be fired in Forward, Neutral or Reverse. However, you may find that the coupler doesn't open when firing the coupler at high speeds. Reduce the voltage setting on your transformer if this occurs and run your engine at a slower speed before firing the coupler. If the coupler continues to open erratically, try lubricating the knuckle with light oil as indicated in Fig. 3.

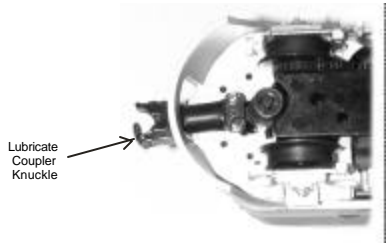

Figure 3: Lubricating The ProtoCoupler Knuckle

For multiple heading purposes, only one of the two Proto-Couplers will function at any one time. Use the coupler direction switch as shown in Fig. 1 on page 3 to select either the front or rear coupler. Simply slide the switch toward the direction of the coupler you want to make active.

NEUTRAL-ACTIVATED CAB CHATTER SOUNDS

Your engine is equipped with four dispatcher-to-engineer "Cab Chatter" radio transmissions that occur every 2 to 30 seconds. Each sequence will play at random intervals to eliminate repetition. While the sounds are selected to play randomly by the microprocessor, there is no guarantee that you won't hear the same message repeated twice or more times.

SQUEAKING BRAKE SOUNDS

ProtoSound equipped engines feature the ability to play the sound of squeaking brakes whenever your engine slows in speed. There are two settings for activating the squeaking brake sounds. The default setting allows the brake sounds to play while the engine is in forward or reverse and the transformer throttle is lowered from a high setting to a low setting (14 volts to 8 volts or less). The second

Throttle Down From High Voltage To Low

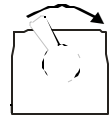

Listen For The Squeaking Brake Sounds

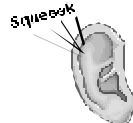

setting requires that a bell button be used to “arm” the brake feature and is explained in more detail in the “Activating Freight Yard Sounds” section found later in this manual. The sound itself is a stored record on the ProtoSounds software chip and will always play the same brake sound for the same three second length each time the voltage is reduced from high to low. Some practice may be required to synchronize the playing of the brake sounds with the movement of the engine. It is not uncommon for the engine to stop before the brake sound is completed. Operators will find that by coordinating the movement of the throttle setting from 8 volts to off will allow the engine to maintain its movement while the brake sounds play. *Note: The brake sounds will not be heard if the transformer throttle is not set above 14 volts and/or not reduced below 8 volts.*

TIPS ON USING THE SQUEAKING BRAKE FEATURE

Because the squeaking brake feature always plays for approximately 3 seconds, it is possible that the brake sounds will play longer or shorter than what visually seems prototypical. You will find that by practicing with the brake feature, you can quickly determine how quickly to throttle down and what speeds and voltage settings give you the most prototypical braking effect.

Typical users will find the feature to be a very realistic way to simulate the sound of an engine slowing down for curves, crossings or coming to a stop at a station, side track or switch yard. As mentioned above, you will find that initially your engine may continue to play the brake sounds once your engine comes to a stop or that the sounds stop prematurely before the engine comes to a complete halt. For example, if you simply run the engine and turn the throttle off quickly, the brake sounds will likely continue playing even though the engine has come to a complete stop. This annoying effect can be eliminated by simply practicing with the brake feature. In no time, you will quickly learn how to “feather” the throttle to keep the engine moving while the brake sounds play and then turning the throttle off just as the sounds stop. Remember that once you stop the engine, you should turn the throttle to the off position if you don’t want to activate the Freight Yard Sounds feature described later in this manual.

The ProtoSound squealing brake feature also has the ability to simulate the squeal of wheel flanges when your train enters a curve at high speeds. The same brake squealing sound plays, but you don’t need to reduce the transformer throttle to activate the squealing sounds. To play the squealing sounds as wheel flange sounds, trigger the brake feature using either method 1 or 2 above. Once triggered set the transformer throttle setting at 14 volts or higher. As your engine enters a curve (or anywhere on the layout) quickly “flick” your transformer whistle button about half way. This “flicking” action causes the transformer to release a short DC signal that ProtoSounds reads as an indicator to activate the brake sounds. The engine won’t slow

down even though the sounds play. This simulates the wheel flange squeal of a train travelling through a turn too quickly.

Note: Consistent activation of the wheel flange squealing is determined by the condition of your transformer's whistle button rectifier disc. Older rectifier discs may not release a clear and strong enough DC signal required by ProtoSound's computer to play the wheel flange squealing.

SELF-RECHARGING BATTERY BACKUP

ProtoSounds® state-of-the-art design includes a self-recharging battery backup system for improved performance at any speed. The self-recharging battery backup system is automatically turned on or off whenever track power is turned on or off. There are no switches to turn on or off to enjoy the benefits of the automatic battery backup system. The battery ensures that power to the sound system will remain on during directional changes, setting RESET options, or when traveling over dirty track and switches.

The battery is a rechargeable NiCad type which is continually charged from the track when power is applied. NiCad batteries are a dry battery and should not leak or cause any damage to your locomotive and will last up to five years or longer. If you notice that the sounds seem distorted or garbled at low voltages or become silent when power from the transformer is shut off, the battery may be going bad. Before replacing the battery, you should put the engine in NEUTRAL and leave the transformer throttle at about 12 volts for fifteen minutes. This should temporarily recharge the battery. If the garbled or distorted sounds are reduced, then your battery charge has worn down. You can give your battery a full charge by leaving the engine ON in NEUTRAL for 16 to 18 hours.

REPLACING THE PROTOSOUND BATTERY

The ProtoSound® battery is a special NiCad 7-cell, 8.4v battery - NOT the 6-cell, 7.2v battery found in most convenience stores. The 6-cell NiCad is NOT recommended for use with ProtoSound® applications. Replacement ProtoSound® batteries are available from MTH ProtoSound Electronics at 7020 Columbia Gateway Drive, Columbia, MD 21046. A standard 9v alkaline battery can be substituted as a temporary fix, but since alkaline batteries can't take a charge, it will eventually wear down. Regardless, it should give you a week to a couple of months use while you wait for your replacement ProtoSound® battery to arrive.

PASSENGER ANNOUNCEMENTS (PFA)

ProtoSounds is now equipped with operator controlled passenger station announcements, hereby known as PFA. This easy to use feature plays digitally reproduced passenger station sounds whenever your engine stops at a train station on your layout. No additional wires or modifications are needed on your layout to enjoy these amazing sound effects. The sounds themselves are randomly generated and randomly “shuffled” on the ProtoSounds software chip. This gives the system the ability to produce different sounds in a different order each time the PFA feature is enabled. These different sounds are heard each time you cycle the transformer throttle from on to off in the same manner that you would cycle the throttle to enter the various states of forward, neutral and reverse. The entire PFA sequence is designed to simulate the arrival, disembarking, embarking, and departure of a train entering and leaving a train station. The sounds include public address arrival and departure messages, passenger disembarking and embarking sounds, conductor voices and general train station ambient sounds. Each is described in more detail in the following sections.

ACTIVATING PASSENGER SOUNDS

Your ProtoSounds equipped engine features an operator controlled passenger station sound set. Once activated, this easy to use feature plays digitally reproduced sounds of a passenger station whenever you stop your engine in the neutral position at a train station on your layout.

ARMING THE PASSENGER SOUNDS FEATURE

Before the passenger station sounds can be heard, ProtoSounds must activate the feature so that the next time the engine enters the neutral position, the sounds can play. The feature can be activated one of two ways.

Option 1: If you are using a separate bell button controller to ring your bell (like the Lionel Railsounds No. 5906 bell activation button) you can activate the feature by pressing and holding the bell button for three seconds or longer (it doesn't matter if you are in forward, neutral or reverse). You will

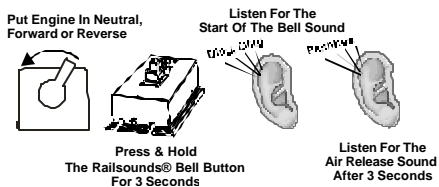

hear the bell chiming turn on and if you listen carefully you should hear an air release sound after three seconds have passed at which time you can release the bell button. *(Note: because the air release sound is hard to hear, we recommend that you count out a full three seconds before releasing the bell button.)* The bell will continue to chime, so if you want to turn off the bell ringing, simply press and release the bell button a second time. If you were in neutral when you triggered the brake feature, interrupt the transformer throttle to enter either forward or reverse to allow the engine to begin running. *(Note: the feature will only be activated in the first direction state you enter after triggering the feature from the neutral position. You cannot interrupt the power twice to enter another direction state and still have the passenger sound feature active.)* Once your engine begins running, you can trigger the sounds to begin playing whenever you enter neutral.

Option 2 If you do not have a separate bell button on your layout, you can still activate the feature with your transformer whistle button. To activate the feature turn on the transformer throttle and get your engine into the neutral position (not RESET). Once in neutral, set the transformer throttle at 8 volts or less and press and hold the whistle button for at least three seconds. You will hear the bell chiming turn on and if you listen carefully you should hear an air release sound after three seconds have passed at which time you can release the whistle button. *(Note: because the air release sound is hard to hear, we recommend that you count out a full three seconds before releasing*

the whistle button.) The bell will continue to chime, so if you want to turn off the bell ringing, simply press and release the bell button a second time.

Interrupt the transformer throttle to enter either

forward or reverse to allow the engine to begin running. *(Note: the feature will only be activate in the first direction state you enter after triggering the feature from the neutral position. You cannot interrupt the power twice to enter another direction state and still have the feature active.)* Once your engine begins running, you can trigger the sounds to begin by entering neutral.

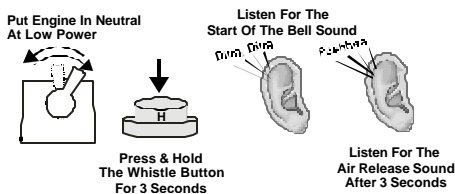

ACTIVATING AND TRIGGERING PASSENGER STATION ANNOUNCEMENTS

Before PFA can be heard the feature must be activated first. Activation is accomplished by holding down the bell button for three or more seconds as described in the Activating and Triggering The Passenger Station Sounds section found earlier on page 8.

Once the feature is activated, PFA will be played the next time the engine enters the neutral position. In order for PFA to begin, power must remain on once the engine enters the neutral position. At this point ProtoSounds has taken over control of your engine and disabled the bell and whistle buttons from any further operator functions. In addition, ProtoSounds has reconfigured the way the DCRU reverse unit functions by disabling the reverse unit state during operation of the PFA feature. This forces the engine to leave your station in the same direction it arrived. The following operator controlled “events” control PFA’s actions and sounds.

Event 1 (Forward) While the locomotive is running in forward (or reverse) PFA is activated by the operator pushing and holding the bell button down for three or more seconds. The locomotive bell begins chiming and can be left on or turned off without disabling PFA.

Event 2 (Neutral Before Reverse) The operator now interrupts the transformer throttle to stop the engine and put it into neutral. If the throttle setting was at 14 volts or higher, ProtoSounds will play the sound of squealing brakes as the engine comes to a stop.

I. Upon stopping of the engine, the operator must immediately turn the throttle back on as the engine sits in neutral. If the bell was not turned off after activating PFA, it now turns off automatically.

Put Engine In Neutral
At Low Power



Note: Failure to turn the throttle back on within 3 seconds of leaving the forward phase will disable PFA and shutdown ProtoSounds. The next time you turn power back on your engine will be in the RESET position. See page 6 for more information.

This is followed by a public address message that the train on track 1 or 2 (whichever track number the arriving public address message stated) is now boarding. Upon completion of the PA message, two conductor voice highlights randomly begin playing. These conductor voices include “Welcome Aboard” and “Tickets Please”. In addition to the two conductor highlights, the station ambient sounds continue and still include passenger footsteps, muffled voices, baggage being moved about, crashing sound and whistling for a taxi. The departing public address message automatically repeats itself every 60 seconds with the highlights and station ambient sounds randomly occurring as long as the system remains in the “neutral before forward” phase.

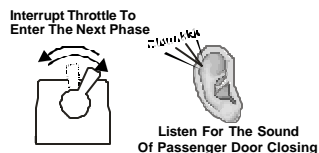

Event 5. (Forward) The operator now interrupts the transformer throttle again to enter the next reverse unit phase; forward. PFA confirms to the operator that it has entered the forward phase by playing a conductor voice yelling “All Aboard!” Immediately after playing “all aboard”, the sound of the doors closing is heard. Within two seconds of the doors closing, the locomotive bell begins chiming and the air compressor pumps start. After approximately 7 chimes of the bell, the engine automatically begins moving out in the forward phase with the bell continuing to ring another 7 chimes before automatically turning off. Once the bell turns off the operator regains control of the transformer whistle and bell buttons and can ring the bell or blow the whistle as usual.

Note: *When entering the forward phase of PFA, it is important to set the transformer throttle at a high enough setting that will allow the engine to begin moving once PFA automatically activates the motors. Otherwise, the engine will just sit still until you increase the throttle setting on the transformer.*

TIPS ON USING THE PFA FEATURES

PFA is a unique feature of ProtoSounds that is completely controlled by the operator. You decide how, when or if you want to utilize the feature. By reviewing following tips you should find solutions or suggestions to the various operating scenarios you might encounter when using PFA.

Tip #1: You can escape the PFA sequence by interrupting the transformer throttle before the first PA (Public Address) arrival message plays in Event 2 (neutral before reverse).

Tip #2: You can terminate PFA at anytime by turning the transformer throttle off for 15 seconds.

Tip #3: You do not have to be in the forward state to utilize PFA. For example if you activate the PFA feature while in reverse and interrupt the throttle to enter neutral, you will be entering neutral before forward rather than neutral before reverse as defined in Event 2 above. Consequently, the forward phase will be rendered inactive by ProtoSounds instead of the reverse state as explained in Event 3. This will allow your train to leave the train station in the same reverse direction that it arrived in.

Tip #4: You can utilize PFA even if you are double-heading with another engine, regardless of whether it is equipped with ProtoSounds or PFA. If the engine isn't equipped with PFA, the only thing to remember is that you not turn up the transformer throttle very high when entering the reverse state found in Event 3. If the throttle is set too high, then the second locomotive will begin vibrating on the track as its motors will be turning in the reverse state since engines not equipped with PFA cannot disable the reverse state and will thus continue powering their own motors. If your second engine is equipped with PFA, it can be disabled by entering RESET function 28. See the section on programming RESET functions on page 17 of this manual to disable PFA.

Tip #5: It is not necessary for the squealing brake sounds to be heard to play the PFA sounds. For example, the brake sounds won't be heard if the high voltage setting is below 13 volts and the power is interrupted to enter the neutral state.

Tip #6: You can leave any of the event states at any time after entering the state by simply interrupting the transformer throttle. Any sound effects programmed to play in that event will simply not occur. The only exception is Event 2 and Event 5. In Event 2, interrupting the throttle has no affect on PFA until after the PA arrival message has played and the doors have opened. In Event 5, you cannot interrupt PFA until after the engine begins to move. Interrupting the throttle before the engine begins to move has no affect on the locomotive.

PROTOSOUND® VOLUME ADJUSTMENT

Your ProtoSound® system has two types of volume adjustment. A manual turn knob on the bottom of the chassis (See Fig. 4 below) allows you to control all the sounds in the system and a remote control “RESET” option (Option # 6), allows you to control the volume level of the engine sounds remotely from the transformer. Turning the volume adjustment knob clockwise will increase the volume and counterclockwise will lower the volume of all sounds; bell, horn, engine sounds, Cab Chatter, etc.

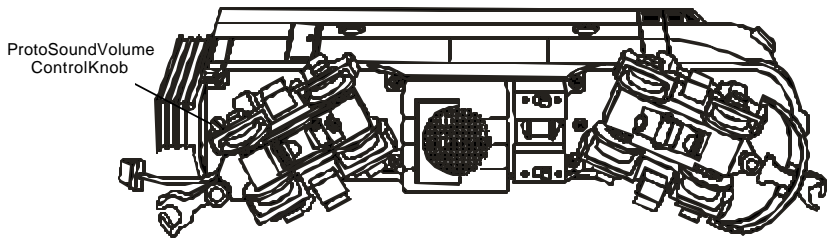

Figure 4: Adjusting The ProtoSound Volume

USING "RESET" TO PROGRAM PROTOSOUNDS®

As mentioned earlier, there are several programmable options in each ProtoSound-equipped engine that can be remotely set from any compatible standard AC transformer equipped with a whistle button. For a list of compatible transformers, see the chart on page 33. This hands-off approach gives you unprecedented control of your railroad empire's motive power never before seen in model railroading. Each programmable feature can be accessed whenever your engine is in the RESET state as described earlier on page 4. By following the instructions below you will find the programming easy and straight forward.

ENTERING RESET OPTIONS

ProtoSound® is equipped with a few programmable features that are accessed in the RESET state by moving the transformer throttle up and down between full voltage and low voltage (6 to 8 volts) without shutting the transformer off completely. Each time this is done you advance, one feature at a time, through the available options. An air-release sound is heard each time the throttle is advanced. In addition, there are special sounds to tell you what RESET position you are in.

For example, if you want to select Feature 2, you put the engine in RESET, and move the throttle up and down from full throttle to low two times. After the second advance, you will hear two "clinks" indicating that the computer is now in Feature 2. Advance the throttle again and you will hear three "clinks" for

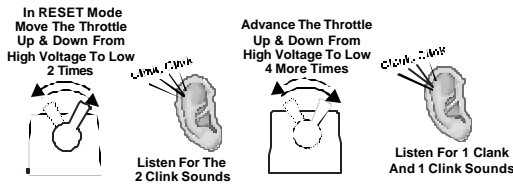

Feature 3. Advance it two more times and you will hear a "clank" indicating that you are now in Feature 5. Advance the throttle two more times and you will hear a "clank" and two "clinks" indicating Feature 7. ((5 throttle advancements = 1 clank) + (2 throttle advancements = 2 clinks)). "Clank + "Clink" + "Clink" = Feature 7. You can advance the throttle as quickly as you like (though you may not hear the air-release sounds) and the computer will still remember the number of times the throttle is advanced by playing back the number of "Clinks" and "Clanks" to confirm the feature you've selected.

SETTING THE ENGINE VOLUME

Of all the sounds that come with each ProtoSound-equipped locomotive, the one most often turned down is that of the engine volume because it is the one sound normally heard whenever the engine is running and is what usually can become tiresome to the ear over prolonged running sessions. The volume adjustment is controlled through RESET Feature 6.

To access the feature, advance the transformer throttle to put the engine in RESET. Move the throttle up and down, as described on page 5, 6 times. After you hear the “clank” and “clink” indicating that you are in Feature 6,

press the whistle button to select the engine volume level you desire.

Pushing the whistle button once will give you full volume, which is the factory setting.

Pushing the whistle button a second time

will give you 50% volume, pushing it a third time will give you 25% volume and pushing it a fourth time will give you no engine sound. The microprocessor will immediately play the sound level each time the whistle button is pushed so that you can decide if it is acceptable. You can recycle through the four choices by simply continuing to press the whistle button.

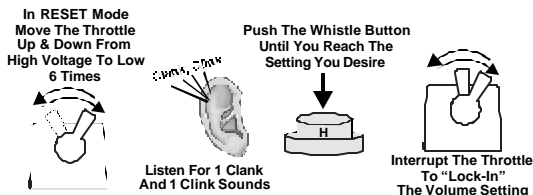

Once you have decided on the appropriate volume level, turn the transformer throttle off and on again or press the transformer direction switch to lock in your selection. The volume adjustment will remain set at the level you have chosen until you change it again. Regardless of the engine volume setting, the horn, bell, compressor and Cab Chatter sounds will function normally. In fact because only the engine volume is affected by selections in Feature 6, when you select 0 volume, you can still hear the horn, bell and Cab Chatter sounds when the engine is running or in neutral.

PROGRAMMING FOR A SEPARATE BELL BUTTON CONTROLLER

To operate ProtoSounds with a separate bell button controller, like the Lionel® No. 5906 bell button, you will need to wire the controller to your transformer and track as shown in Fig. 5. Once the button is wired, ProtoSounds comes preprogrammed to allow you to operate the bell by simply pushing the bell button once.

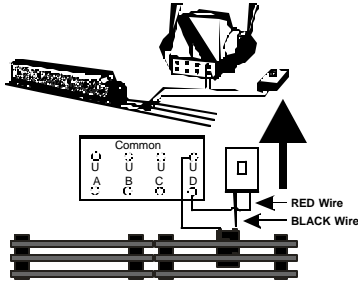

Figure 5: Wiring Up A Bell Button

To turn the bell off, push the button again. If the bell doesn't function when you press the button, you may need to re-program ProtoSounds to operate with a separate bell button controller. To do this enter RESET and go to Feature 20. (See the section *Using RESET*

To Program

ProtoSounds® on page 17.) Once in Feature 20, press the whistle button

and wait for the module to sound a bell ding(s). Continue pushing the whistle button until the module plays back two dings (signifying that the module has been programmed for a bell button). Simply turn the throttle off and then on again to "Lock-In" the new setting. To reset the computer to its original factory (default) setting (no separate bell button operation), repeat the above procedure but keep pushing the whistle button until the computer only responds with one bell ding.

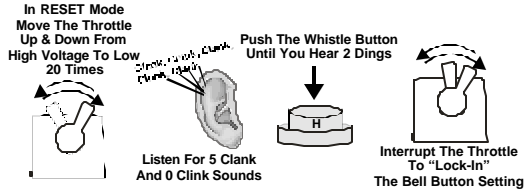

PROGRAMMING FOR SQUEAKING BRAKE OPERATION

ProtoSounds can be programmed for squeaking brake operation in three different manners; (1)Squeaking brakes can be activated by bell button control, (2)they can be programmed for continuous operation subject to throttle changes or (3)they can be programmed to be turned off. The default setting is (2) Squeaking brakes are activated for full-time operation as

described on page 8. To change the default setting, enter RESET and go to Feature 45. (See the section **Using RESET To Program ProtoSounds® on page 17**). Once in Feature 45, press the whistle button and wait for the module to sound a bell ding(s). Continue pressing the whistle button until the module plays back one ding for option 1 - Squeaking brakes are activated by the bell

button. Press the whistle button again until the module plays back two dings for option 2 - squeaking brakes are activated for full-time operation, or press the whistle button again until the module plays back

three dings for option 3 -Squeaking brakes off. Once you have decided on the desired setting, simply turn the throttle off and then on again to “Lock-In” the new setting. To reset the computer to its original factory default setting (option 2 - squeaking brakes are activated for full-time operation, repeat the above procedure but keep pushing the whistle button until the module only responds with one bell ding.

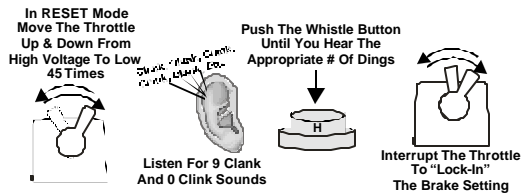

PROGRAMMING FOR HORN IN NEUTRAL OPERATION

If you are operating your engine with a separate bell button and want to blow your horn when your engine is in neutral, you will need to program ProtoSounds to do so as the factory setting only allows the horn to blow in forward or reverse. To do this, enter RESET and go to Feature 25. (See the section **Using RESET To**

Program ProtoSounds® on page 17.) Once in Feature 25, press the transformer whistle button and wait for

ProtoSounds to sound a bell ding(s). Continue pressing the whistle button until ProtoSounds sounds two bell dings (signifying that

ProtoSounds has been programmed to sound the horn in neutral). Turn the throttle off and then on again to “Lock-In” your selection. Now, whenever you are in neutral, you can blow the horn with the transformer whistle

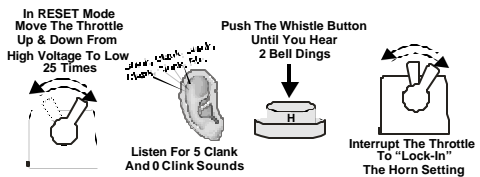

button. To reset ProtoSounds to its original factory setting of no horn in neutral, repeat the above procedure but keep pressing the whistle button in Feature 25 until ProtoSounds only dings once instead of twice.

Note: When "Horn In Neutral" is set, the bell will only operate with a separate bell button and the horn will not sound in neutral if the transformer throttle setting is over 11 volts. At 11 volts or higher, ProtoSounds may arm the coil coupler for operation whenever the whistle button is pressed and the engine is in neutral.

PROGRAMMING FOR PROTOCOUPLER OPERATION

ProtoSounds comes with a RESET feature that allows the operator to remotely turn off the ProtoCoupler functions. This is especially useful when double or triple-heading ProtoSound equipped engines since every engine equipped with a

ProtoCoupler will fire when prompted to by the operator. By turning off the ProtoCoupler operation on certain engines, you can fire the couplers open on the other engines without uncoupling the engines from each other. To turn

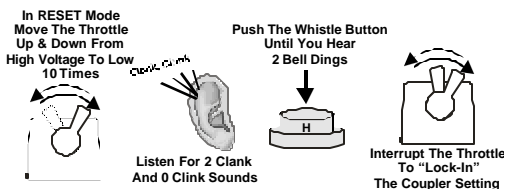

the ProtoCoupler function off, enter RESET and go to Feature 10. (See the section on **Using RESET To Program ProtoSounds®** on page 17.) Once in Feature 10, press the transformer whistle button and wait for ProtoSound to sound a bell ding(s). Continue pressing the whistle button until ProtoSounds sounds two bell dings (signifying that the ProtoCoupler option has been turned off). Simply turn the transformer throttle off and then on again to lock in the new setting.

PROGRAMMING FOR PFA OPERATION

ProtoSounds® is equipped with a RESET setting to turn off the Passenger Station Sound Proto-Effects (PFA) features. This is especially useful if you are double-heading engines that are both equipped with PFA. You may not want to stop at a yard and have both engines playing their PFA sound effects. To turn off PFA, enter RESET and go to Feature 28. (See the section on **Using RESET To Program ProtoSounds®** on page 17). Once in Feature 28, press the transformer whistle button and wait for ProtoSounds® to sound a bell ding(s). Continue pressing the whistle button

on and off until ProtoSounds sounds two bell dings (signifying that the PFA features have been turned off). Simply turn the transformer throttle OFF and then ON again to lock in the new setting. To reset ProtoSounds® to its original factory setting of Squeaking Brakes and PFA on, repeat the above procedure but keep pressing the whistle button in Feature 28 until ProtoSounds® only dings once instead of twice.

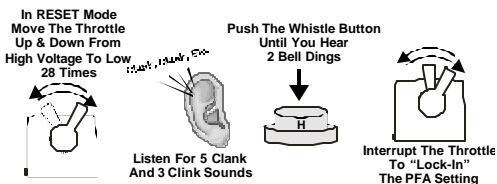

ACTIVATING REMOTE LOCK-OUT CONTROL

ProtoSound® equipped engines feature a RESET setting that allows the operator to remotely “lock” the engine into forward, neutral or reverse. This is especially useful on layouts that feature “blocked” track sections. The lockout feature comes from the factory in the OFF position, meaning it is not active when you first take the engine out of the box. This is done to prevent novice operators from accidentally locking their engine into forward, neutral or reverse and then mistakenly thinking that the engine’s electronics have failed. To activate the Remote Lockout Control setting, go to RESET Feature 40 (See the section entitled *Using*

RESET To Program ProtoSounds® on page 17). Once in Feature 40, press the transformer whistle button and wait for ProtoSounds to sound a bell ding. Continue pressing the whistle button until

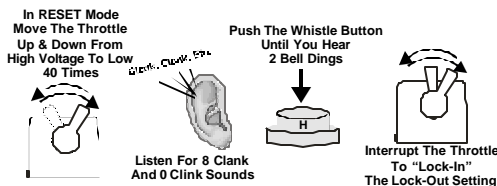

ProtoSounds sounds two bell dings signifying that the Remote Lockout Control has been selected. To lock in the setting, simply turn the throttle all the way off and then back on again. To turn the Remote Lockout Control setting back off, go back to Feature 40 and press the whistle button until only one bell ding sounds. To lock in the setting, simply turn the transformer throttle off and then back on again. Alternatively, you can go to RESET Feature 18 to reset all

ProtoSound features back to their original factory defaults including Remote Lockout Control.

RESETTING ALL PROTOSOUND® OPTIONS TO FACTORY DEFAULTS

ProtoSounds® is equipped with a RESET feature (Feature 18) that resets all programmable options back to their original factory settings. This is a useful feature if you find your engine not operating the way you think it should and don't want to take the time to check each RESET feature one at a time. To reset all the RESET features back to their original factory

settings, enter RESET and go to Feature 18. (See the section entitled *Using*

RESET To Program

ProtoSounds® on page

17). Once in Feature 18,

press the transformer

whistle button and wait for

ProtoSounds to sound a

garbled bell sound.

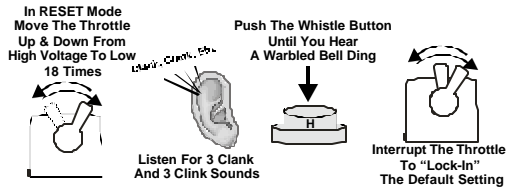

TURNING OFF CAB CHATTER SOUNDS

"Cab Chatter" sounds occur in the neutral position every 2 to 30 seconds. There are four "Chatter" messages which play at random times. This helps to eliminate repetitive and boring messages. While the sounds are selected to play randomly by the unit's computer, there is no guarantee that you won't hear the same message repeated twice or more times. If you don't want to hear the Cab Chatter sounds, they can be turned off through Feature 23. To turn off the Cab Chatter sounds, enter RESET and go to Feature 23. (See the section *Using RESET To Program ProtoSounds®* on Page 17.) Once in Feature 23, press the transformer whistle button and wait for ProtoSounds to sound a bell ding(s). Continue pressing the whistle button until ProtoSounds sounds two bell dings (signifying that the module has been programmed to turn the Cab Chatter off). Simply turn the transformer throttle off and then on again to lock in your selection. To turn the Cab Chatter sounds back on again, repeat the above process, but keep pressing the transformer whistle button in Feature 23 until ProtoSounds only sounds one bell ding.

REVERSE UNIT LOCK-OUT OPERATION

ProtoSound's unique design eliminates the need for a lock-out switch on the locomotive by allowing the customer to lock the engine into any directional state (forward, neutral or reverse) from the transformer. This will allow users to run the engine on layouts equipped with block signals or stop stations which would normally cycle the engine back into neutral. The feature must be first turned on by accessing RESET Feature 40 (See section entitled *Using RESET To Program ProtoSounds®* on page 17).

LOCKING THE ENGINE INTO FORWARD OR REVERSE

To lock the engine into Forward or Reverse, use the transformer throttle to enter Forward or Reverse (whichever state you want to lock the engine into) and while the engine is moving press the whistle button. **WHILE THE HORN IS BLOWING TURN THE THROTTLE OFF AND THEN LET GO OF THE WHISTLE BUTTON.** After about one second, you will hear a short horn blast. **QUICKLY TURN THE THROTTLE BACK ON AGAIN.** Your engine is now locked into Forward or Reverse and it will remain so until you unlock the engine, even if you wait a year to run your engine again.

UNLOCKING THE ENGINE

Unlocking the engine is a similar procedure. **WHILE THE ENGINE IS MOVING, PRESS THE WHISTLE BUTTON. WHILE THE HORN IS BLOWING, TURN THE THROTTLE OFF AND THEN LET GO OF THE WHISTLE BUTTON.** After three seconds without power you will hear one chime of the RESET bell. **TURN ON THE POWER AGAIN.** Your engine is now in RESET and will operate normally once you interrupt power and enter the forward direction.

LOCKING THE ENGINE INTO NEUTRAL

To lock the engine into the NEUTRAL position, **PUT THE ENGINE IN NEUTRAL AND WITH THE THROTTLE STILL ON, PRESS THE WHISTLE BUTTON. WHILE THE WHISTLE BUTTON IS BEING PRESSED, TURN OFF THE THROTTLE AND LET GO OF THE WHISTLE BUTTON.** After about one second, you will hear a short blast

of the horn. **QUICKLY TURN THE POWER BACK ON AGAIN.** Your engine is now locked into NEUTRAL.

***NOTE:** When locking the engine in the Forward or Reverse positions, the whistle button will blow the horn. But when locking the engine into the NEUTRAL position, the whistle button may turn on or off sounds of the bell, coupler arming or coupler firing depending on the transformer throttle voltage settings prior to the user's attempt to lock out the engine. Remember, the horn doesn't blow in NEUTRAL (unless you programmed it to do so using Feature 25. See page 20 for details), only the bell rings or the coupler operates in NEUTRAL. While it doesn't make any difference on how the lockout function operates, you may hear one of the three different NEUTRAL-activated sounds.*

To unlock the engine from the NEUTRAL position, follow the process to unlock the engine in the Forward or Reverse directions above.

OIL & LUBRICATION INSTRUCTIONS

In order for the engine to perform correctly and quietly, it is important that the chassis be lubricated before operation. Lubrication should include all truck block bushings and pickup rollers to prevent them from squeaking. Use light household oil and follow the lubrication points marked "L" in Fig. 7 below.

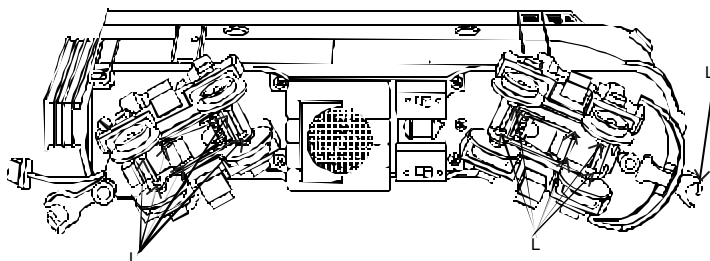

Figure 7: Lubricating The Truck

The locomotive's internal gearing in both power trucks has been greased at the factory and shouldn't need additional grease until after 50 hours of operation or one year whichever comes first. Grease cannot be added to the internal gearing until the body is removed from the chassis which is held in place by four Phillips screws. The screws are located on each end of the chassis' as seen in Fig. 9 on the following page. After removing the screws, lift the body away from the chassis and lay the body next to the chassis.

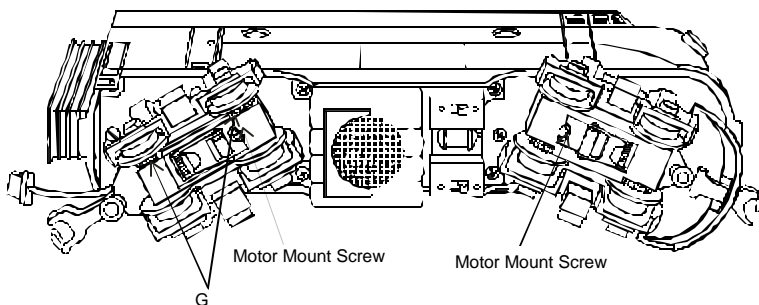

Figure 8: Greasing The Power Trucks

Next, remove the truck blocks from the chassis by unscrewing the large Phillips motor mount screw on the bottom of each truck block (See Fig. 8).

Once the motor mount screw has been removed, pull the motor away from the truck block and lightly coat the motor worm gear and bronze drive gear (in the truck block) with grease. Reassemble the truck and motor, being careful not to pinch the pickup and ground wires between the truck block and motor mount. Repeat the procedure for the other motor and truck and then reassemble the chassis to the body. When reassembling the chassis and body, be very careful that the lighting wire harnesses are not caught between the body and chassis as this can lead to a short which may damage the electronic circuit boards beyond repair.

In addition to the truck block internal gearing, it is a good idea to lubricate the outside truck block "idler" and "drive" gears with grease. Use the diagram shown in Fig. 7. above as a guide and add grease to the points marked with a "G".

Periodically, check the locomotive wheels and pickups for dirt buildup as this can significantly affect the engine's ability to perform properly. Dirty track and dirty wheels can cause both poor electrical contact as well as poor traction, especially on elevated track sections. Finally, dirt and oil build up can prematurely wear out the neoprene traction tires.

TRACTION TIRE REPLACEMENT INSTRUCTIONS

Your locomotive is equipped with two neoprene rubber traction tires on each power truck. While these tires are extremely durable and long-lasting there may arise a time where they will need to be replaced. Should this occur, you will need to remove the trucks and truck sides on the truck block from the chassis in order to slip the new tire over the grooved drive wheel. We suggest you follow the disassembly instructions found in the

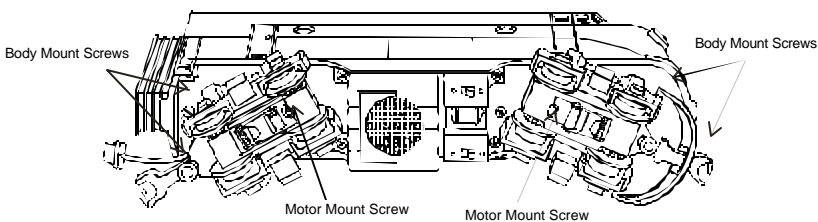

Lubrication section on the preceding pages to disassemble the chassis and truck blocks from the body.

Before the new tire can be installed, you must make sure the old tire has been completely removed from the groove in the drive wheel. Use a razor blade or small flatblade screwdriver pry away any remains left from the old tire that may still be in the drive wheel groove. Once the old tire has been completely removed, slip the new tire onto the wheel. You may find it useful to use two small flatblade screwdrivers to assist you in stretching the tire over the wheel. Be careful to avoid twisting the tire when stretching it over the wheel. If a twist occurs, the tire will have to be removed and reinstalled or a noticeable wobble in your engine will occur when operating the locomotive. In addition, it is important to make sure that the tire is fully seated inside the groove. Any portion of the tire extending out of the groove can cause the engine to wobble. A razor blade can be used to trim away any excess tire that doesn't seat itself inside the groove properly.

Once the new tire(s) are in place, reassemble the truck sides to the truck blocks and then reassemble the chassis to the body. Replacement tires are available directly from MTH Electric Trains.

HEADLIGHT REPLACEMENT

The F-3 locomotive's headlights are controlled by constant voltage circuits inside the locomotive body. The headlight(s) can be easily removed from their lampholders should the bulbs expire. To remove the bulb, follow the body removal instructions found in the Lubrication section on the preceding pages. Once the cab has been separated from the chassis, gently unplug the bulb's wiring harness from the socket on the constant voltage circuit. Replacement bulbs are available directly from MTH Electric Trains.

TROUBLE SHOOTING *PROTOSOUND*® PROBLEMS

Although ProtoSound® has been designed and engineered for ease of use, some questions may arise during initial operation. The following table should answer most questions. If you find that your problem can't be resolved with this manual, contact MTH ProtoSound Electronics (7020 Columbia Gateway Drive, Columbia, MD 21046, 410-381-2580) for additional assistance.

HORN PROBLEMS	REMEDY
The horn seems distorted at low voltages.	Your battery may be undercharged or dead. Try recharging the battery as explained in the battery sections.
When I press the whistle button, the bell comes on instead.	You are trying to operate the horn in neutral. The horn will only operate in Forward or Reverse unless you program ProtoSounds through Feature 25. See the instructions in the section entitled "Using RESET to Program ProtoSounds".
I can't get the horn to blow when I press the whistle button.	You may be pressing the whistle button too quickly. Most older AC transformers contain a two-step whistle button that releases a DC signal onto the track. It is this DC signal that tells the horn to blow. However, because the signal is weaker when the whistle button is depressed fully, the ProtoSound circuit may not recognize the signal. Try pressing the whistle button slower, taking approximately 1 second to fully depress the button.
BELL PROBLEMS	REMEDY
When I press the whistle button to activate the bell, the horn sounds.	You are trying to ring the bell in Forward or Reverse. The bell only operates in Neutral unless you have programmed ProtoSounds to recognize a separate bell button.
When I press the whistle button to activate the bell, I arm the coupler.	Reduce the voltage on the transformer before pressing the whistle button to activate the bell. The bell will only come on at 8 volts or less.
When I press the whistle button to activate the bell, the bell only rings once.	You are trying to ring the bell in RESET instead of neutral. Interrupt the power twice to enter Neutral, set the voltage at 8 volts or less and press the whistle button to activate the bell.
I can't get the bell to ring when I press the whistle button.	You may be pressing the whistle button too quickly. See the 3rd remedy in the horn section above.
The bell won't work with a separate bell button.	ProtoSounds must be programmed in order for a separate bell button to function. Enter RESET function number 20 (see the section entitled "Using RESET to Program ProtoSounds") and press the whistle button until the bell sounds two dings. Simply turn the throttle off and then on again to lock in the new setting.

PREMIER LINE

COUPLER PROBLEMS	REMEDY
The ProtoCoupler won't let the engine uncouple on the "Fly".	The power required to fire the coupler open when the engine is on the "Fly" may be greater than the ProtoSound system is capable of providing. As a result, you may experience times when the coupler won't fire open. Unfortunately, the only solution is to stop the engine and fire the coupler in Neutral. If that doesn't resolve the problem, try lubricating the coupler knuckle and rivet as explained in the ProtoCoupler Operation section.
I can't get the coupler to arm or fire open when I press the whistle button.	You may be pressing the whistle button too quickly. See the third remedy in the horn section above. Another possibility is that ProtoSounds has been programmed to turn the coupler function off. See the section entitled "Using RESET to Program ProtoSounds"
Only one coupler will function when I press the whistle button.	Only one coupler can operate at any one time. Use the coupler selection switch on the bottom of the chassis to choose which coupler you want active.
DIESEL START/CAB CHATTER	REMEDY
Sometimes the diesel start sounds don't occur when I first turn power on.	Occasionally the diesel engine start up sounds may not occur when power is turned back on within 5 seconds of being shut off. Wait 10 -- 15 seconds before repowering.
Sometimes the Cab Chatter sounds don't play.	The Cab Chatter sounds only play in neutral and ProtoSounds may be programmed to turn these sounds off. See the section entitled "Using RESET to Program ProtoSounds"
LOCKOUT PROBLEMS	REMEDY
I can't get the engine to run after I power up the transformer. It sits still with the diesel compressor sounds running.	The engine is locked out into the Neutral position. Follow the unlocking procedures in the Lockout Section.
The engine won't lock out into Forward, Neutral or Reverse even after the short horn blast sounds.	You are waiting too long to turn the throttle back on after the short horn blast sounds. The power must be turned back on immediately after the short horn blast sounds or the engine will go back into RESET. See the lockout procedure in the Lockout Section.
VOLUME PROBLEMS	REMEDY
When I try to run the engine, the diesel volume is OFF or very low.	The diesel volume has been programmed at a reduced volume or to be silent. Go to RESET Feature 6 and adjust the volume. See the section entitled "Using RESET to Program ProtoSounds" for more information.
When I try to set the diesel volume, it resets itself to the original volume after I selected the new volume.	You are trying to set the volume with a poorly charged or dead backup battery. See the section on Battery Backup for more information.
When I try to set the Diesel Volume to O Volume, I still hear the cab chatter sounds.	When the diesel volume is set to O, you will hear the Cab Chatter sounds because setting the diesel volume only controls the sound of the diesel engine itself. All other sounds, including Cab Chatter, the horn and bell will continue to play at the volume level set by the manual volume control knob located on the bottom of the chassis. See the section entitled "ProtoSound Volume Adjustment" for more information.
The sounds seem distorted, especially when the whistle or bell is activated.	The overall ProtoSound volume has been set to high creating the distorted sounds. Try turning the volume control knob located on the bottom of the chassis counter clockwise to reduce the overall volume level.

BATTERY PROBLEMS	REMEDY
I get no sounds when the engine shifts between the direction states.	The battery may be dead or needs charging. See the Battery Backup section for more information.
After I turn off my transformer, my engine continues to make sounds before quitting with a ding of its bell.	ProtoSounds continues to sound for approximately 10 seconds after power to the track has been shut off.
The sounds distort at low voltages.	The battery is insufficiently charged or dead. Follow the recharging instructions found in the section entitled "Self Recharging Battery Backup System".
A repeating horn blast occurs after the power has been shut down.	The battery is insufficiently charged or dead. Follow the recharging instructions found in the section entitled "Self Recharging Battery Backup System".
RESET PROBLEMS	REMEDY
When I first turn the power on, the engine will not begin to run. I have to turn the throttle off and then on again to get the engine to operate.	This is normal behavior. When power to the track is first turned on, ProtoSounds enters a "RESET" phase at which time the engine undergoes a system check. Power must be interrupted to get the engine into the Forward Phase. See the section entitled "DCRU Reverse Unit Operation" for more information.
Whenever I interrupt the power from RESET to enter Forward, the engine goes back into RESET instead of Forward. I know this occurs because the bell dings twice.	Whenever ProtoSounds enters RESET after power has been off for more than 15 seconds, the microprocessor initiates a system check to determine that everything is in working order. This system check requires 2.2 seconds to complete during which time the engine will play the diesel startup sounds. We recommend that you don't interrupt the power in RESET until the diesel startup sounds have completed. This will guarantee that the system check will have been completed since the startup sounds take longer than 2.2 seconds to play. If the problem persists, we recommend that you operate the throttle with a slower movement as you interrupt the power in RESET and enter the Forward Phase
BRAKE SOUND PROBLEMS	REMEDY
When the transformer is throttled down, the sounds won't play.	The brake features has not been activated. See the section on activating the brake feature for more information. The throttle voltage setting on the transformer is either not starting high enough or ending low enough to trigger the brakes sounds. Try increasing the throttle setting to 14 volts or higher before throttling down to 8 volts or less.
The brake sounds continue to play even after the engine stops.	The brake feature sound record lasts for three seconds. With practice you can control how quickly you should stop the engine to keep it in sequence with the sound of the brake's squeaking.
The brake feature was activated in neutral after the engine was running in forward, but the brake sounds would not play when triggered after the engine went back into forward or reverse.	The brake feature will only remain enabled if it is triggered in the first direction state you enter after activating the feature in neutral. You cannot interrupt the power twice to enter another direction state and still have the brake feature active. Therefore, in order to make the brake sound feature operate in forward, you must first activate the feature in the neutral position that occurs after the engine was in the reverse state.
After triggering the brake sound and stopping the engine in neutral, the engine begins making passenger station sound effects.	After you trigger the brake sounds, you cannot stop the engine in neutral and leave the track power on without activating the passenger station sounds. If you don't want to hear the passenger station sounds after entering neutral, turn the power off for three seconds to disable the passenger station sound effects.

PFA PROBLEMS	REMEDY
The PFA feature does not begin even after stopping the engine and hearing the brake sounds.	The power was not turned back on once the engine enter the neutral state thus disabling PFA. The transformer throttle was interrupted too quickly in neutral thus disabling PFA. Leave the throttle on in neutral until after the PFA arrival message plays.
The PFA sound effects occasionally repeat themselves.	ProtoSounds has a built-in random number generator that randomly selects each sound clip to play. Because there are only a total of 8 sound clips available in each PFA event, it is probable that a sound can occasionally be repeated one or more times.
Once in PFA, the engine never goes in reverse.	So that the passenger station sound effects and operation is as realistic as possible, ProtoSounds disables the reverse unit state whenever PFA is enabled. This way the engine never goes into reverse as the operator cycles through the various PFA events.
When the engine enters PFA event 5, the bell automatically comes on.	PFA has a built-in command to turn on the bell when the system enters Event 5. After approximately 15 rings of the bell, it automatically will turn off.
Whenever PFA is enabled, pressing the whistle and bell buttons has no affect.	Because PFA must control various effects in each PFA event, the bell and whistle functions are disabled until either the PFA events have been completed, or the engine is shut down for 3 or more seconds.
I can't get PFA to begin when the engine is stopped in the neutral position.	It is possible that PFA was never enabled or has been disabled. Try reactivating the feature by holding down the bell button for three or more seconds.

PROTOSOUND RESET FEATURE CHART

The following chart lists the available features found in your ProtoSound equipped locomotive. The default settings for each feature as well as the operation sequence of the feature are listed in separate columns. You can reset all features to their original factory settings by accessing Feature 18 in RESET and press and hold the transformer whistle button until you hear a soft, warbled bell sound.

RESET #	OPERATION	DEFAULT	CLANKS/CLINKS
6	Engine Volume	Full Volume	1 Clank/5 Clinks
10	Coupler ON/OFF	Coupler ON	2 Clanks/0 Clinks
18	Reset Default Settings		3 Clanks/3 Clinks
20	Remote Bell Button	Bell Button Active	4 Clanks/0 Clinks
23	Cab Chatter	Cab Chatter ON	4 Clanks/3 Clinks
25	Whistle In Neutral	Whistle In Neutral OFF	5 Clanks/0 Clinks
27	Chuff Rate	Full Chuff Range	5 Clanks/2 Clinks
28	Brake/PFA Enabled	Brake/PFA ON	5 Clanks/3 Clinks
40	Lockout Enabled	Lockout OFF	8 Clanks/0 Clinks
45	Squeaking Brakes	Brakes Always ON	9 Clanks/0 Clinks

TRANSFORMER WIRING CHART

ProtoSounds® is designed to work with any standard AC transformer that uses a “Pure Sine-Wave” format. The chart below lists the many Lionel® compatible transformers, such as the Lionel KW or ZW models. In addition, the chart details how the terminals on these compatible transformers should be attached to your layout. The Trainmaster system from Lionel® (marked with an asterisk below) will not function correctly with ProtoSounds without disrupting the sound effects. Therefore, whenever ProtoSounds senses that the Trainmaster system is being used, it automatically disables ProtoSound’s sound effects. The operator retains control over the engine, but no sound effects will play.

Transformer Model	Center Rail	Outside Rail	Min/Max. Voltage	Power Rating	Transformer Type
Lionel 1032	U	A	5-16v*	90-Watt	Standard
Lionel 1032M	U	A	5-16v*	90-Watt	Standard
Lionel 1033	U	A	5-16v*	90-Watt	Standard
Lionel 1043	U	A	5-16v*	90-Watt	Standard
Lionel 1043M	U	A	5-16v*	90-Watt	Standard
Lionel 1044	U	A	5-16v*	90-Watt	Standard
Lionel 1053	U	A	8-17v	60-Watt	Standard
Lionel 1063	U	A	8-17v	60-Watt	Standard
All-Trol	Left Terminal	Right Terminal	0-24v	300-Watt	Electronic
Cab-1/Powermaster	A	U	0-18v	135V.A.	Electronic
Dalee Hostler	Left Terminal	Right Terminal			
Lionel LW	A	U	8-18v	75-Watt	Standard
Lionel KW	A or B	U	6-20v	190-Watt	Standard
MRC Tech II	Left Terminal	2 nd From Left	0-15v*	40V.A.	Electronic
Lionel MW (not recommended)	Outside Track Terminal	Inside Track Terminal	5-16v*	50V.A.	Electronic
R.O.W.	Red Terminal	Black Terminal	0-24v	384-Watt	Standard
Lionel RS-1	Red Terminal	Black Terminal	0-18v	50V.A.	Electronic
Lionel RW	U	A	9-19v	110-Watt	Standard
Lionel SW	U	A	Unknown	130-Watt	Standard
Lionel TW	U	A	8-18v	175-Watt	Standard
Lionel ZW	A or D	U	8-20v	275-Watt	Standard
MTH Z4000	Red	Black	5-18v	390-Watt	Electronic

**ProtoSounds needs over 14 volts of power to work properly. Overloading or using in-line accessories with this transformer may lower the peak voltage below ProtoSound’s requirements.*

O-31 OPERATION

While the MTH F-3 diesel is more than capable of operating on O-31 curves and switches, you may find that certain light freight cars are prone to derailling when being pulled or pushed by the MTH F-3 through O-31 switches. Should this occur, we suggest adding weight to the cars making them heavier and less likely to derail.

WARNING:

When using electrical products, basic safety precautions should be followed including the following:

- Read this and all related manuals (transformer/power supply, locomotive, etc.) thoroughly before using this device.
- This device is not recommended for children under eight years of age without adult supervision.
- MTH recommends parents examine the toy transformer used to power this device periodically for conditions that may result in the risk of fire, electric shock, or injury to persons, such as damage to the primary or output cord, plug blades, housing or other parts (including proper functioning of the circuit breaker), and that, in an event such conditions exist, the transformer should not be used until properly repaired.

F - 3 A B A

Powered A unit (Lead) Parts

Item Name	Part #	Name and Number	Part #
) Shell (S.P. # 6180)	FC-2100153	30.) Screw	IA-0000110
) Shell (C.P. # 2373)	FC-2100154	31.) Screw	IA-0000012
(both A units have same #)		32.) Screw	IA-0000002
) Shell (Reading # 276)	FC-2100155	33.) Heat sink	AI-0000015
) Diaphragm	FI-0000017	(3.0X20.0X16.0mm)	
) Vent (red)	FC-2100199	34.) Screw	IA-0000010
) Vent (gray)	FC-2100200	35.) Bracket (proto-sounds)	IH-0000072
) Vent (black)	FC-2100201	36.) Insulator	ID-0000024
) Handrail (18.5mm long)	FC-2100104	37.) Insulator washer	ID-0000025
(nickel)		38.) Screw	IA-0000003
) Handrail (18.5mm long)	FC-2100156	39.) Proto-sound board (top)	AE-4500001
(yellow)		40.) Proto-sound chip	N/A
) Handrail (31.5mm long)	FC-2100105	41.) Proto-sound board (bottom)	AD-4500001
(nickel)		42.) Battery	BG-4000001
) Handrail (31.5mm long)	FC-2100157	43.) Battery leads	BC-4000009
(yellow)		44.) Screw	IA-0000001
) Lens (portal)	FA-0000001	45.) Motor Mount	BI-0000009
) Air horns (single)(nickel)	FC-2100118	46.) Rubber band	BI-4500004
) Air horns (single)(black)	FC-2100158	47.) Motor	BE-0000022
) Vent (top)(black)	FC-2100161	48.) Volume pot	BI-0000026
) Vent (top)(brown)	FC-2100162	(w/ 230.0mm long wires)	
1.) Handrail (46.5mm long)	FC-2100123	49.) Bracket (volume pot)	IH-0000023
(nickel)		50.) Washer	ID-0000034
1.) Handrail (46.5mm long)	FC-2100163	51.) Nut	IC-0000007
(yellow)		52.) Screw	IA-0000111
2.) Lens	FA-2130006	53.) Wire harness	BC-0000014
(headlight)(8.0X7.0X6.0mm)		54.) Screw	IA-0000025
3.) Number board housing	FC-2100164	55.) T-bar	IG-0000001
(orange)		56.) Coupler (non-operating)	DD-4000005
3.) Number board housing	FC-2100165	57.) Spring	IE-0000017
(black)		(6.5X14.0mm)(0.5mm thick wire)	
3.) Number board housing	FC-2100166	58.) Washer	ID-0000022
(gray)		59.) E-clip	IF-0000002
4.) Windows	FA-2130007	60.) Screw	IA-0000023
5.) Handrail (12.0mm long)	FC-2100126	61.) Ladder (truck side)(black)	FC-2100109
(nickel)		62.) Wire strap (metal)	IH-0000012
5.) Handrail (12.0mm long)	FC-2100167	63.) Screw	IA-0000016
(yellow)		64.) Ladder (chassis)(black)	FC-2100107
5.) Number board (# 6180)	FG-2100034	65.) Screw	IA-0000044
5.) Number board (# 2373)	FG-2100035	66.) Insulator (pick-up)(top)	BD-0000026
5.) Number board (# 276)	FG-2100036	67.) Bracket speaker	IH-0000003
7.) Screw	IA-0000035	68.) Plate (coil coupler direction)	ID-0000056
8.) Engineer	FI-0000001	69.) Switch (large)	BB-0000006
9.) Interior detail	FC-2100168	70.) Screw	IA-0000025
) Grommet	IH-000001C	71.) Screw	IA-0000034
1.) Bulb (grain of wheat)(6V)	CG-0000013	72.) Speaker	BF-4500008
(65.0mm long wires w/ black plug)		73.) Proto-coupler	DD-0000001
2.) Bulb (mars light)	CB-0000001	74.) Pilot (black)	DG-2130002
3.) Bracket	IH-0000071	74.) Pilot (red)	DG-2130003
4.) Screw	IA-0000022	75.) Fuel tank (black)	FC-2100128
5.) Chassis (powered A unit)	DH-2100011	76.) Truck (powered) (2 axle)	DA-2000002
5.) Bulb (grain of wheat)(6V)	CA-000001C	77.) Nut	IC-0000001
(65.0mm long wires w/ blue plug)		78.) Insulator (pick-up)(bottom)	BD-0000001
7.) Spacer (3.5X6.0X6.0mm)	ID-0000055	79.) Pick-up	BD-0000005
8.) Bulbs (grain of wheat)(6V)	CC-0000004	80.) Screw	IA-0000015
(2 bulbs)(65.0mm long wires w/ black plug)		81.) Traction tires	DE-0000018
9.) CV board (w/ mars light)	AG-0000017	82.) Truck side (b back)	DB-2150002
9.) CV board (w/out mars light)	AG-0000014	83.) Fan shroud (black)	FC-2100169
		83.) Fan shroud (brown)	FC-2100170

Powered A unit (Lead) Parts

Name and Number	Part #
84.) Fan	FC-2100171
85.) Pin (for fan)	FC-2100172
86.) Door (S.P.) (complete w/ all hardware)(right rear)	FC-2100173
86.) Door (C.P.) (complete w/ all hardware)(right rear)	FC-2100174
86.) Door (Reading) (complete w/ all hardware)(right rear)	FC-2100175
87.) Door (S.P.) (complete w/ all hardware)(right front)	FC-2100176
87.) Door (C.P.) (complete w/ all hardware)(right front)	FC-2100177
87.) Door (Reading) (complete w/ all hardware)(right front)	FC-2100178
88.) Door (S.P.) (complete w/ all hardware)(left rear)	FC-2100179
88.) Door (C.P.) (complete w/ all hardware)(left rear)	FC-2100180
88.) Door (Reading) (complete w/ all hardware)(left rear)	FC-2100181
89.) Door (S.P.) (complete w/ all hardware)(left front)	FC-2100182
89.) Door (C.P.) (complete w/ all hardware)(left front)	FC-2100183
89.) Door (Reading) (complete w/ all hardware)(left front)	FC-2100184
90.) Handrail (cab roof)(red)	FC-2100185
90.) Handrail (cab roof)(nickel)	FC-2100186
90.) Handrail (cab roof)(yellow)	FC-2100187
91.) Builder's plate	FC-2100188
92.) Lens (marker)(red)	FA-0000002
93.) Lens (Headlight)(S.P. only)	FA-0000003
94.) Fireman	FI-0000009
95.) Screw	IA-0000037
96.) Bracket (battery)(flat mounted)	IH-0000074
97.) Lift ring (black)	FC-2100189
97.) Lift ring (brown)	FC-2100190

Powered (Lead)
A-Unit

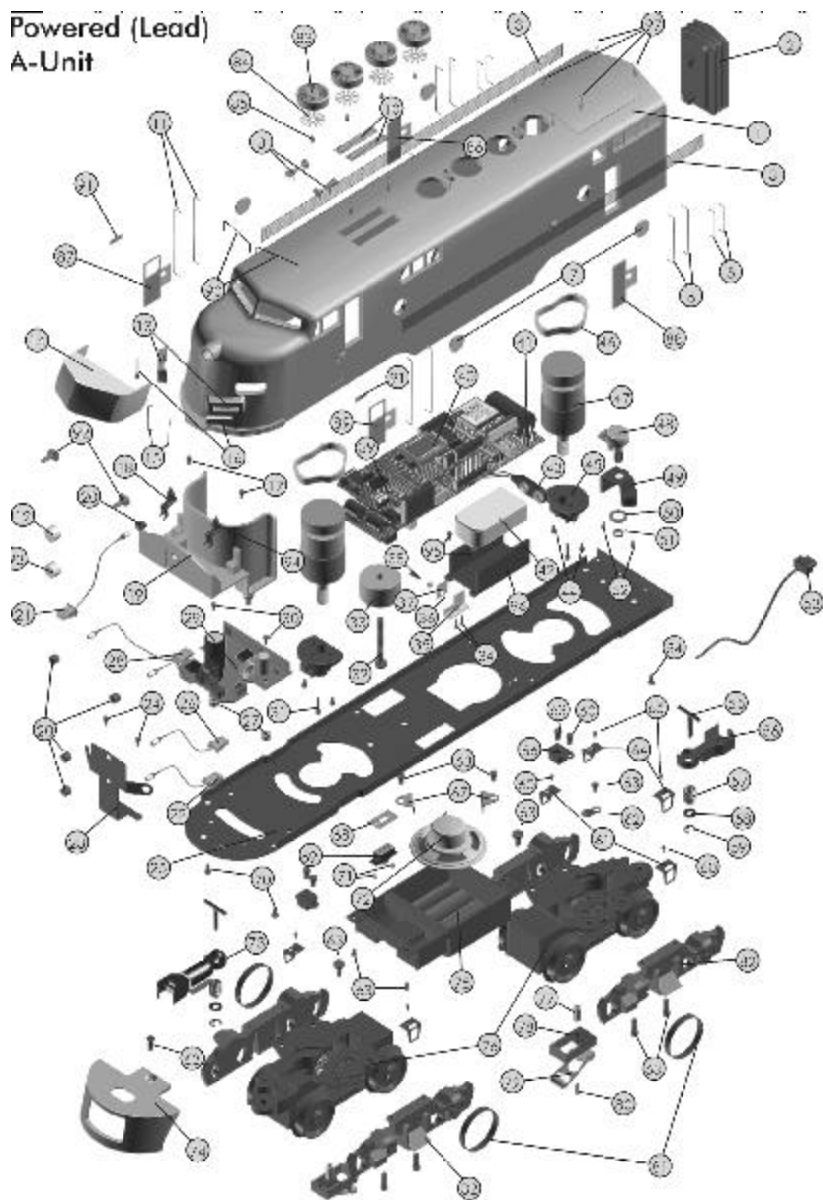

Powered A unit Parts

Name and Number	Part #	Name and Number	Part #
1.) Shell (S.P. # 6181)	FC-2100191	44.) Screw	IA-0000044
1.) Shell (C.P. # 2373)	FC-2100154	45.) E-clip	IF-0000002
1.) Shell (Reading # 279)	FC-2100192	46.) Washer	ID-0000026
2.) Diaphragm	FI-0000017	47.) Spring	IE-0000022
3.) Vent (red)	FC-2100199	48.) Coupler (non-operating)	DD-4000005
3.) Vent (gray)	FC-2100200	49.) T-bar	IG-0000001
3.) Vent (black)	FC-2100201	50.) Screw	IA-0000025
5.) Handrail (nickel)	FC-2100104	51.) Wire strap (metal)	IH-0000012
5.) Handrail (yellow)	FC-2100156	52.) Insulator (pick-up)(top)	BD-0000026
6.) Handrail (31.5mm long)	FC-2100105	53.) Chassis (powered A unit)	DH-2100011
7.) Lens (portal)	FA-0000001	54.) Spacer	ID-0000050
8.) Air horns (single)(nickel)	FC-2100118	55.) Wire harness	BC-0000015
8.) Air horns (single)(black)	FC-2100158	56.) Screw	IA-0000095
10.) Vent (top)(black)	FC-2100161	57.) Rubber band	BI-4500004
10.) Vent (top)(brown)	FC-2100162	58.) Motor	BE-0000022
11.) Handrail (nickel)	FC-2100123	59.) Motor mount	BI-0000009
11.) Handrail (yellow)	FC-2100163	60.) Screw	IA-0000001
12.) Lens	FA-2130006	61.) Screw	IA-0000012
13.) Number board housing (orange)	FC-2100164	62.) DCRU	AC-0000001
13.) Number board housing (black)	FC-2100165	63.) Bracket (DCRU)(U shaped)	IH-0000039
13.) Number board housing (gray)	FC-2100166	64.) Lens (headlight)(S.P. only)	FA-0000003
14.) Number board (# 6181)	FG-2100037	65.) Screw	IA-0000112
14.) Number board (# 2373)	FG-2100035	66.) Fan shroud (black)	FC-2100169
14.) Number board (# 279)	FG-2100038	66.) Fan shroud (brown)	FC-2100170
15.) Handrail (nickel)	FC-2100126	67.) Fan	FC-2100171
15.) Handrail (yellow)	FC-2100167	68.) Pin (for fan)	FC-2100172
16.) Windows	FA-2130007	69.) Door (S.P.)	FC-2100173
17.) Screw	IA-0000035	(complete w/ all hardware)(right rear)	
18.) Engineer	FI-0000001	69.) Door (C.P.)	FC-2100174
19.) Interior detail	FC-2100168	(complete w/ all hardware)(right rear)	
20.) Grommet	IH-0000010	69.) Door (Reading)	FC-2100175
21.) Bulbs	CC-0000004	(complete w/ all hardware)(right rear)	
22.) Lens (marker)(red)	FA-0000002	70.) Door (S.P.)	FC-2100176
23.) Bracket	IH-0000071	(complete w/ all hardware)(right front)	
24.) Screw	IA-0000022	70.) Door (C.P.)	FC-2100177
25.) Bulb	CG-0000013	(complete w/ all hardware)(right front)	
26.) Bulb	CA-0000010	70.) Door (Reading)	FC-2100178
27.) Screw	IA-0000110	(complete w/ all hardware)(right front)	
28.) CV board (w/mars light)	AG-0000017	71.) Door (S.P.)	FC-2100179
28.) CV board (w/out mars light)	AG-0000014	(complete w/ all hardware)(left rear)	
29.) Spacer	ID-0000055	71.) Door (C.P.)	FC-2100180
30.) Screw	IA-0000025	(complete w/ all hardware)(left rear)	
31.) Proto-coupler	DD-0000001	71.) Door (Reading)	FC-2100181
32.) Screw	IA-0000016	(complete w/ all hardware)(left rear)	
33.) Pilot (black)	DG-2130002	72.) Door (S.P.)	FC-2100182
33.) Pilot (red)	DG-2130003	(complete w/ all hardware)(left front)	
34.) Fuel tank (black)	FC-2100131	72.) Door (C.P.)	FC-2100183
35.) Truck (powered) (2 axle)	DA-2000002	(complete w/ all hardware)(left front)	
36.) Truck side (black)	DB-2150002	72.) Door (Reading)	FC-2100184
37.) Screw	IA-0000015	(complete w/ all hardware)(left front)	
38.) Pick-up	BD-0000005	73.) Builder's plate	FC-2100188
39.) Insulator (pick-up)(bottom)	BD-0000001	74.) Handrail (cab roof)(red)	FC-2100185
40.) Nut	IC-0000001	74.) Handrail (cab roof)(nickel)	FC-2100186
41.) L adder (truck side)(black)	FC-2100109	74.) Handrail (cab roof)(yellow)	FC-2100187
42.) Screw	IA-0000023	75.) Lift ring (black)	FC-2100189
43.) L adder (chassis)(black)	FC-2100107	75.) Lift ring (brown)	FC-2100190

* Requires Exchange

Powered A-Unit

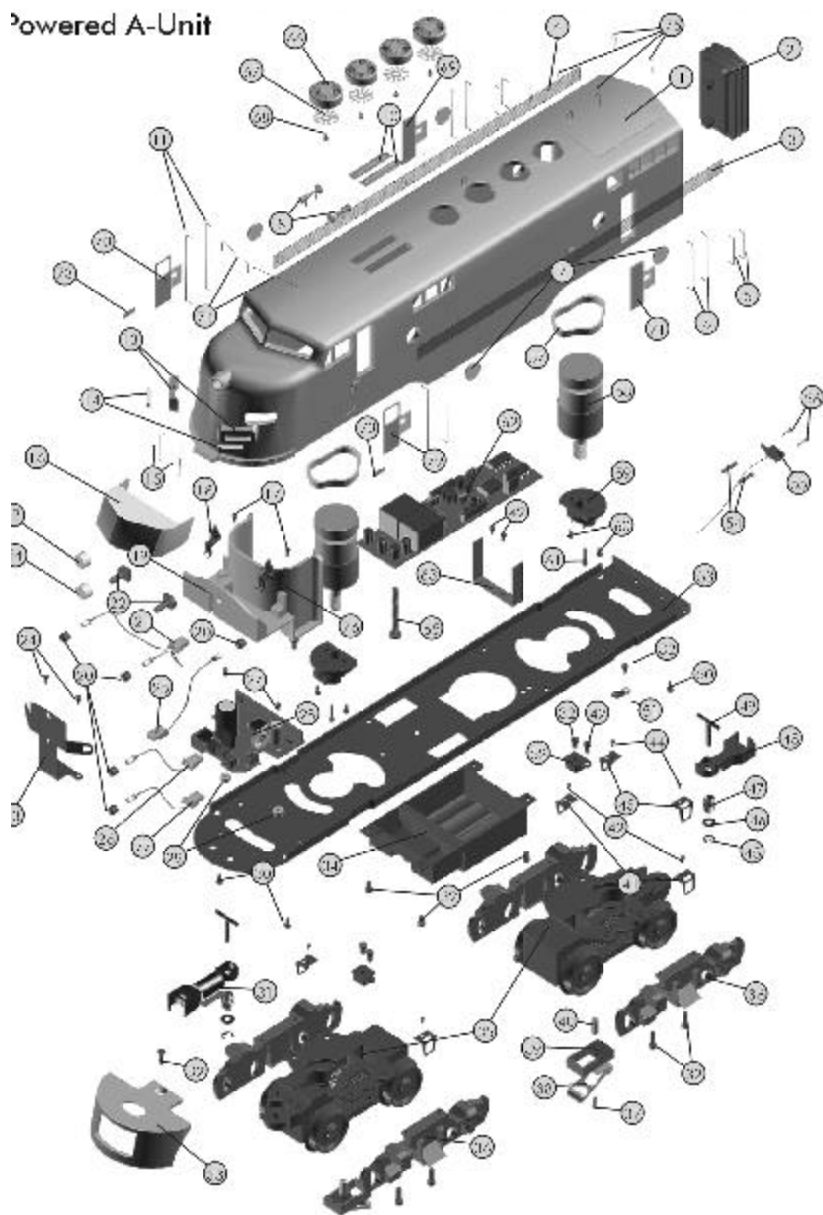

SERVICE & WARRANTY INFORMATION

HOW TO GET SERVICE UNDER THE TERMS OF THE LIMITED ONE YEAR WARRANTY

For warranty repair, do not return your product to the place of purchase unless it was purchased from Mike's Train House in Columbia, MD. Instead, follow the instructions below to obtain warranty service as our dealer network is not prepared to service the product under the terms of this warranty.

1. First, write, call or FAX MTH Electric Trains, 7020 Columbia Gateway Drive, Columbia, MD 21046, 410-381-2580 (FAX No. 410-381-6122), stating when it was purchased and what seems to be the problem. You will be given a return authorization number to assure that your merchandise will be properly handled upon its receipt.
2. CAUTION: Make sure the product is packed in its original factory packaging including its foam and plastic wrapping material so as to prevent damage to the merchandise. The shipment must be prepaid and we recommend that it be insured. ***A cover letter, including your name, address, daytime phone number, Return Authorization number, a copy of your sales receipt and a full description of the problem, must be included to facilitate the repairs. Please include the description regardless of whether you discussed the problem with one of our service technicians when contacting MTH for your Return Authorization number.***
3. Please make sure you have followed the instructions carefully before returning any merchandise for service.

LIMITED ONE YEAR WARRANTY

This item is warranted for one year from the date of purchase against defects in material or workmanship. We will repair or replace (at our option) the defective part without charge for parts or labor, if the item is returned to the address below within one year of the original date of purchase. This warranty does not cover items that have been abused or damaged by careless handling. Transportation costs incurred by the customer are not covered under this warranty.

This warranty gives you specific legal rights and you may have other rights which vary from state to state.

ProtoSounds® is a trademark of MTH Electric Trains. DCRU® is a registered copyright of QS Industries, Inc. Lionel® and Railsound® are registered trademarks of Lionel L.L.C.